

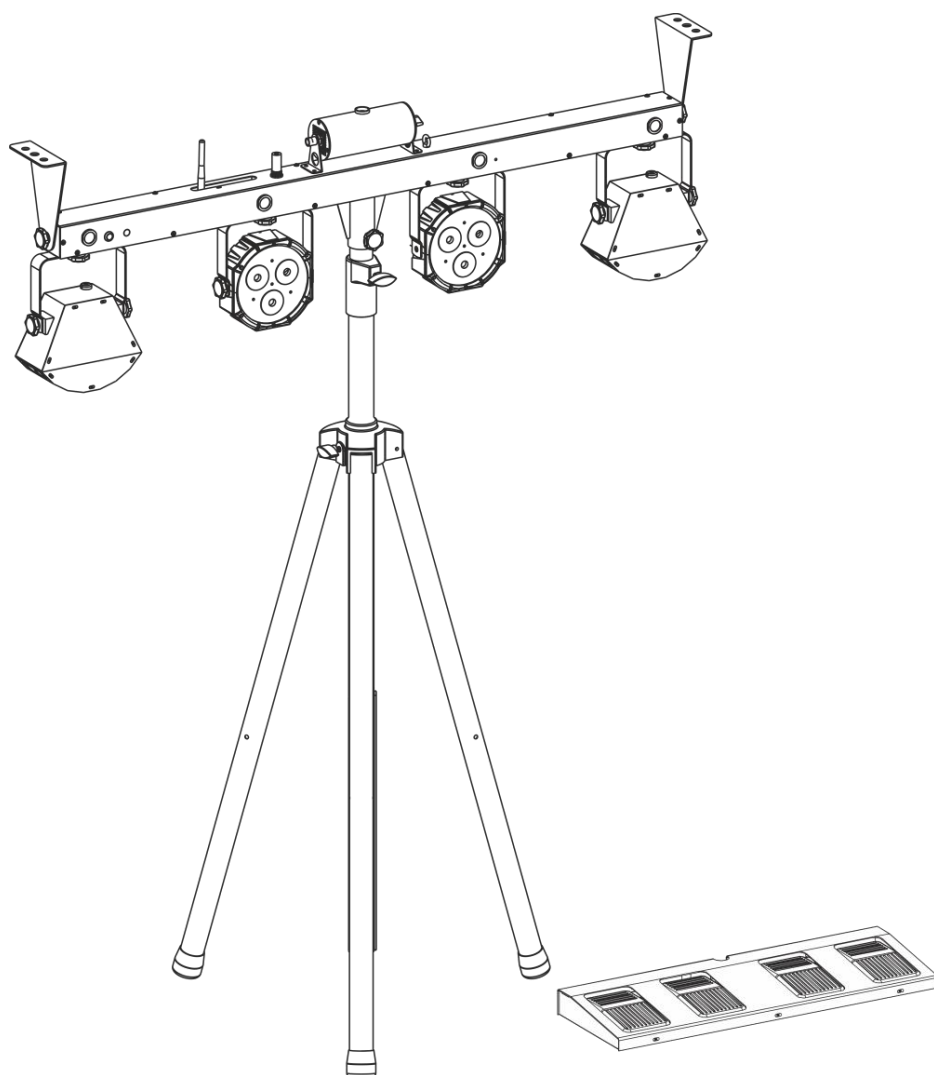

MANUAL



ENGLISH

QFX Compact Light FX Set V1

Ordercode: 30276

Table of contents

Warning3

 Unpacking Instructions.....3

 Safety Instructions4

 Operating Determinations6

 Laser safety for a Class 3B Laser Product6

 Rigging7

 Connection with the mains.....8

 Return Procedure.....9

 Claims.....9

Description of the device.....10

 Features10

 Frontside.....11

 Backside11

 Remote Control.....12

 Footswitch12

Installation.....13

Set Up and Operation13

 Control Modes.....14

 One QFX Compact Light FX Set (Built-in programs).....14

 One QFX Compact Light FX Set (Sound-controlled)14

 One QFX Compact Light FX Set (Manual Mode)14

 Multiple QFX Compact Light FX Sets (Master/Slave Mode)14

 Multiple QFX Compact Light FX Sets (DMX Control)15

 Fixture Linking.....16

 Data Cabling.....16

 Control Panel.....17

 Control Mode17

 DMX Addressing17

 Menu Overview18

 Main Menu Options.....19

 1. Built-in Programs.....19

 1.1 PAR / Derby mode19

 1.2 Laser mode20

 1.3 Flash mode20

 1.4 Mix mode20

 2. Sound-controlled20

 2.1 PAR / Derby mode20

 2.2 Laser mode20

 2.3 Flash mode21

 2.4 Mix mode21

 3. Manual Mode.....21

 4. DMX Mode21

 5. Master / Slave Mode.....21

 6. Settings.....22

 DMX Channels22

 3 Channels22

 5 Channels24

 9 Channels25

 27 Channels26

Maintenance28
 Replacing the Fuse28

Troubleshooting29
 No Light29
 No Response to DMX.....29

Product Specifications31

Dimensions32

Notes34

Warning



**For your own safety, please read this user manual carefully
before your initial start-up!**



Unpacking Instructions

Immediately upon receiving this product, carefully unpack the carton and check the contents to ensure that all parts are present, and have been received in good condition. Notify the dealer immediately and retain packing material for inspection if any parts appear damaged from shipping or the carton itself shows signs of mishandling. Save the carton and all packing materials. In the event that a fixture must be returned to the factory, it is important that the fixture be returned in the original factory box and packing.

Your shipment includes:

- QFX Compact light Fx Set
- Carrying bag
- Schuko to IEC power cable (1,75 m)
- 2 keys for the Interlock
- Remote plug
- Remote control
- Footswitch
- 2 brackets, 3 screws (1 screw for stand)
- Stand with carrying bag
- User manual

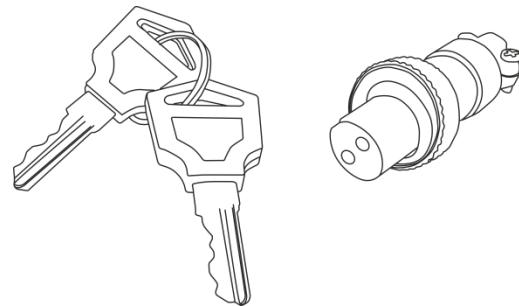
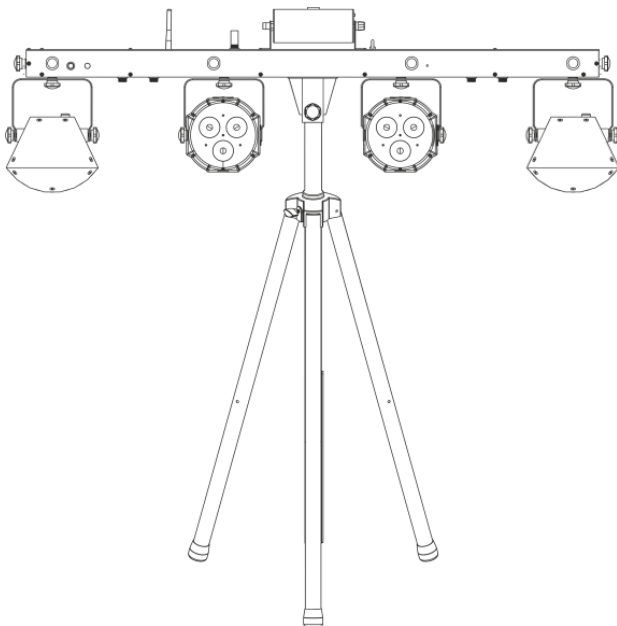

**CAUTION – Class 3B LASER RADIATION WHEN
OPEN AVOID DIRECT EXPOSURE TO BEAM**



CAUTION! Eyedamages!!!
Never look directly into the lightsource!!!
Never project a single laser point!!!



CAUTION!
Keep this device away from rain and moisture!
Unplug mains lead before opening the housing!



Safety Instructions

Every person involved with the installation, operation and maintenance of this device have to:

- be qualified
- follow the instructions of this manual



CAUTION! Be careful with your operations.
With a dangerous voltage you can suffer
a dangerous electric shock when touching the wires!



Before the initial start-up, please make sure that there is no damage caused by transportation. Should there be any, consult your dealer and do not use the device.

To maintain perfect condition and to ensure a safe operation, it is absolutely necessary for the user to follow the safety instructions and warning notes written in this manual.

Please consider that damages caused by manual modifications to the device are not subject to warranty.

This device contains no user-serviceable parts. Refer servicing to qualified technicians only.

IMPORTANT:

The manufacturer will not accept liability for any resulting damages caused by the non-observance of this manual or any unauthorized modification to the device.

- Never let the power cord come into contact with other cables! Handle the power cord and all connections with the mains with particular caution!
- Never remove warning or informative labels from the unit.
- Never use anything to cover the ground contact.
- Never place any material over the lens.
- Never look directly into the light source.
- Never leave any cables lying around.
- Never aim the laser beam at people or animals!
- Never use the device during thunderstorms, unplug the device immediately.
- Never point a laser at aircraft, this is a federal offense.
- Never point unterminated laser beams into the sky.
- Never open the laser housing. The high laser power levels inside of the protective housing can start fires, burn skin and will cause instant eye injury.
- Never expose the lens to direct sunlight, not even for a short period. This may damage the light effect or even cause fire.
- Do not insert objects into air vents.
- Do not connect this device to a dimmerpack.
- Do not open the device and do not modify the device.
- Do not point lasers at highly reflective surfaces such as windows, mirrors and shiny metal. Even laser reflections can be hazardous.
- Do not expose the output optic (aperture) to cleaning chemicals.
- Do not use laser if the laser appears to be emitting only one or two beams.
- Do not use laser if housing is damaged or open, or if optics appear damaged in any way.

- Do not operate laser without first reading and understanding all safety and technical data in this manual. Never look into the laser aperture or laser beams.
- Do not switch the device on and off in short intervals, as this would reduce the device's life.
- Do not shake the device. Avoid brute force when installing or operating the device.
- Do not touch the device's housing bare-handed during its operation (housing becomes hot).
- After set up and prior to public use, test laser to ensure proper function. Do not use the laser if any defect is detected. Do not use, if the laser emits only one or two laser beams rather than dozens/hundreds, as this could indicate damage to the diffraction grating optic, and could allow emission of higher laser levels.
- Only use device indoor, avoid contact with water or other liquids.
- Only operate the fixture after having checked that the housing is firmly closed and all screws are tightly fastened.
- Only operate the device after having familiarized with its functions.
- Avoid flames and do not put close to flammable liquids or gases.
- Always check the regulations when using a class 3B laser product.
- Always check and position the laser before anybody enters the room, when the laser is facing an area with people.
- Always keep case closed while operating.
- Always allow free air space of at least 1 m around the unit for ventilation.
- Always disconnect power from the mains, when device is not used or before cleaning! Only handle the power-cord by the plug. Never pull out the plug by tugging the power-cord.
- Make sure that the device is not exposed to extreme heat, moisture or dust.
- Make sure that the available voltage is not higher than stated on the rear panel.
- Make sure that the power-cord is never crimped or damaged. Check the device and the power cord from time to time.
- If the external cable is damaged, it has to be replaced by a qualified technician.
- If the lens is obviously damaged, it has to be replaced. So that its functions are not impaired, due to cracks or deep scratches.
- If device is dropped or struck, disconnect mains power supply immediately. Have a qualified engineer inspect for safety before operating.
- If the device has been exposed to drastic temperature fluctuation (e.g. after transportation), do not switch it on immediately. The arising condensation water might damage your device. Leave the device switched off until it has reached room temperature.
- If your Showtec device fails to work properly, discontinue use immediately. Pack the unit securely (preferably in the original packing material), and return it to your Showtec dealer for service.
- For adult use only. Device must be installed out of the reach of children. Never leave the unit running unattended.
- Never attempt to bypass the thermostatic switch or fuses.
- For replacement use fuses of same type and rating only.
- The operation of a class 3B laser show laser is only allowed if the show is controlled by a skilled and well-trained operator familiar with the data included in this manual.
- The user is responsible for correct positioning and operating of the QFX Compact Light FX Set. The manufacturer will not accept liability for damages caused by the misuse or incorrect installation of this device.
- This device falls under protection class I. Therefore it is essential to connect the yellow/green conductor to earth.
- The laser will only work between 10-40°C.
- After 3 hours working, you must shut off the laser and let the laser diode cool off for 30 minutes, otherwise the laser could be damaged and the warranty becomes void.
- Repairs, servicing and electric connection must be carried out by a qualified technician.
- WARRANTY: Till one year after date of purchase.



CAUTION! Eyedamages!!!
Avoid looking directly into the lightsource!!!
(meant especially for epileptics)!!!



Operating Determinations

- This device is not designed for permanent operation. Consistent operation breaks will ensure that the device will serve you for a long time without defects.
- The minimum distance between light-output and the illuminated surface must be more than 1 meter.
- The maximum ambient temperature $t_a = 40^{\circ}\text{C}$ must never be exceeded.
- The relative humidity must not exceed 50 % with an ambient temperature of 30°C .
- If this device is operated in any other way, than the one described in this manual, the product may suffer damages and the warranty becomes void.
- Any other operation may lead to dangers like short-circuit, burns, electric shock, crash etc.

You endanger your own safety and the safety of others!

Laser safety for a Class 3B Laser Product

Laser Light is different from any other light source with which you may be familiar with. The light from this product can potentially cause instant eye injury if not set up and used properly.

Laser light is thousands of times more concentrated than light from any other kind of light source. This concentration of light power can cause instant eye injuries, primarily by burning the retina (the light sensitive portion at the back of the eye). Even if you cannot feel "heat" from a laser beam, it can still potentially injure or blind you or your audience.

Even very small amounts of laser light are potentially hazardous even at long distances. Laser eye injuries can happen quicker than you can blink.

It is incorrect to think that because these laser products split the laser into hundreds of beams or the laser beam is scanned out in high speed, that an individual laser beam is safe for eye exposure. This laser product uses dozens of milliwatts of laser power (Class 3B levels internally). Many of the individual beams are potentially hazardous to the eyes.

It is also incorrect to assume that because the laser light is moving, it is safe. This is not true. Nor, do the laser beams always move. Since eye injuries can occur instantly, it is critical to prevent the possibility of any direct eye exposure. According to the laser safety regulation, it is not legal to aim Class 3B lasers in areas which people can get exposed. This is true even if it is aimed below people's faces, such as on a dance floor.

CAUTION! Only Laser Safety Officers who are officially certified by a regulatory body or authorized training organization are allowed to use class 3B lasers in public. The Laser Safety Officer is responsible for all aspects when using this laser, including following all locally applicable safety laws and regulations. The manufacturer will not accept liability for damages caused by the misuse or incorrect installation of this laser.



CAUTION: AVOID EXPOSURE TO BEAM: Avoid direct eye contact with laser light. Never intentionally expose your eyes or others to direct laser radiation.

Compliance Statement

Your QFX Compact Light FX Set laser has been designed to comply with FDA and IEC Standards for its classification.

The QFX Compact Light FX Set is a Class 3B laser product.

Laser Safety and Compliance Information

The QFX Compact Light FX Set is manufactured to comply with the IEC 60825-1 and in accordance with U.S. Food and Drug Administration (FDA) Standards Listed under FDA Document 21 CFR 1040 and subsequent laser notices.

Product Classification and Manufacturing Label Identification

Laser Classification	Class 3B
Cooling	Cooling fans and TE Cooling
Laser medium (Output)	wavelength 650 nm / Red; Output >150mW wavelength 532 nm / Green; Output >50mW

The legal requirements for using laser entertainment products vary from country to country. The user is responsible for the legal requirements at the location/country of use.

Further guidelines and safety programs for safe use of lasers can be found in the ANSI Z136.1 Standard "For Safe Use of Lasers", available from www.laserinstitute.org. Many local governments, corporations, agencies, military and others, require all lasers to be used under the guidelines of ANSI Z136.1. Laser Display guidance can be obtained via the International Laser Display Association, www.laserist.org.

CAUTION: The use of corrective eye wear or optics for viewing at distances such as telescopes or binoculars within a distance of 100mm may pose an eye hazard.



This laser product is a Class 3B laser and has an interlocked housing.



There are no user serviceable parts inside. Tampering or removing warranty seals will void your products limited warranty.



Combo label with the Product Model Number, Serial Number, Date of Manufacturing, Laser Light Warning Label, Warranty Void Label and Interlocked Housing Label.

Proper Usage Safety and Compliance Information

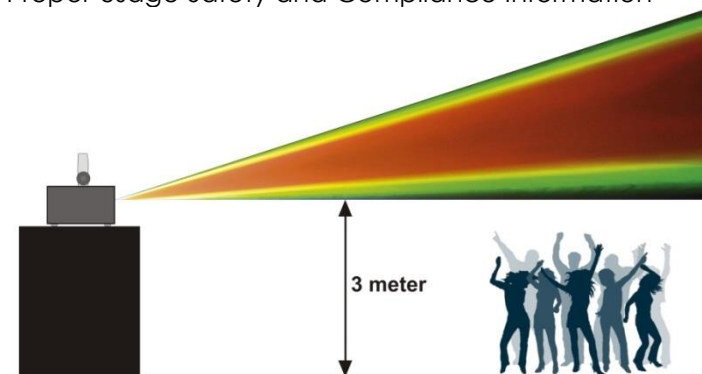

According to FDA Regulations you should operate this product as stated on the left.

Rigging

Please follow the European and national guidelines concerning rigging, trussing and all other safety issues.

Do not attempt the installation yourself !

Always let the installation be carried out by an authorized dealer !

Procedure:

- If the projector is lowered from the ceiling or high joists, professional trussing systems have to be used.
- Use a clamp to mount the projector, with the mounting-bracket, to the trussing system.
- The projector must never be fixed swinging freely in the room.
- The installation must always be secured with a safety attachment, e.g. an appropriate safety net or a safety cable.
- When rigging, derigging or servicing the projector, always make sure that the area below the installation is unavailable for any unauthorized persons.

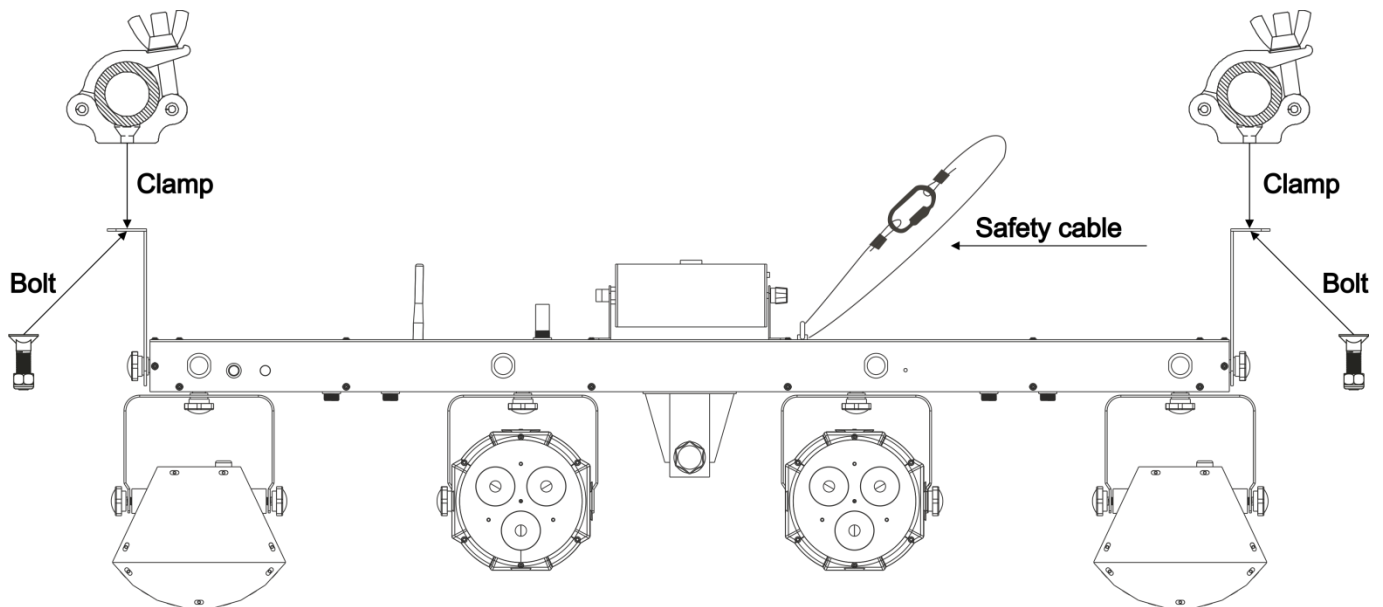

The QFX Compact Light FX Set can be placed on a flat stage floor or mounted to any kind of truss with a clamp.

Improper installation can cause serious injuries and damage of property !

Connection with the mains

Connect the device to the mains with the power-plug.

Always pay attention, that the right color cable is connected to the right place.

International	EU Cable	UK Cable	US Cable	Pin
L	BROWN	RED	YELLOW/COPPER	PHASE
N	BLUE	BLACK	SILVER	NEUTRAL
⊕	YELLOW/GREEN	GREEN	GREEN	PROTECTIVE GROUND

Make sure that the device is always connected properly to the earth!

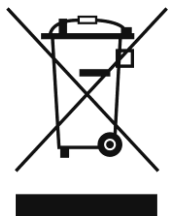



Return Procedure



Returned merchandise must be sent prepaid and in the original packing, call tags will not be issued. Package must be clearly labeled with a Return Authorization Number (RMA number). Products returned without an RMA number will be refused. Highlite will not accept the returned goods or any responsibility. Call Highlite 0031-455667723 or mail aftersales@highlite.nl and request an RMA prior to shipping the fixture. Be prepared to provide the model number, serial number and a brief description of the cause for the return. Be sure to properly pack fixture, any shipping damage resulting from inadequate packaging is the customer's responsibility. Highlite reserves the right to use its own discretion to repair or replace product(s). As a suggestion, proper UPS packing or double-boxing is always a safe method to use.

Note: If you are given an RMA number, please include the following information on a piece of paper inside the box:

- 01) Your name
- 02) Your address
- 03) Your phone number
- 04) A brief description of the symptoms

Claims

The client has the obligation to check the delivered goods immediately upon delivery for any shortcomings and/or visible defects, or perform this check after our announcement that the goods are at their disposal. Damage incurred in shipping is the responsibility of the shipper; therefore the damage must be reported to the carrier upon receipt of merchandise.

It is the customer's responsibility to notify and submit claims with the shipper in the event that a fixture is damaged due to shipping. Transportation damage has to be reported to us within one day after receipt of the delivery.

Any return shipment has to be made post-paid at all times. Return shipments must be accompanied with a letter defining the reason for return shipment. Non-prepaid return shipments will be refused, unless otherwise agreed in writing.

Complaints against us must be made known in writing or by fax within 10 working days after receipt of the invoice. After this period complaints will not be handled anymore.

Complaints will only then be considered if the client has so far complied with all parts of the agreement, regardless of the agreement of which the obligation is resulting.

Description of the device

Features

The Showtec QFX Compact Light FX Set combines 2x LED PAR, 2x Derby, a Laser and a Strobe effect onto a single control bar. The system is complete including a tripod stand, wireless footswitch, IR remote and carrying bags to protect the set during transport.

- Compact strong metal housing
- Input Voltage: 100-240V 50/60Hz
- Continues Power: 45W
- Control mode: Built-in programs, Sound controlled, Manual mode, Master / Slave, DMX
- Sound-controlled via built-in microphone
- DMX-controlled via built-in microphone
- DMX modes: 3, 5, 9, 27 Channels
- Clear 4 Digits Red LED display for all settings
- Power Connection: IEC in- & output
- Data Connector: 3-pole XLR (In/Out)
- Cooling: Convection (no fans) which eliminates the use of fans and noise
- Working temperature: -10°C - 40°C
- Fuse T1,5 AL / 250V
- Safety eye
- Dimensions: 1185 x 110 x 387 mm (LxWxH)
- Weight: 6,6 kg
- Included: 2 keys, Interlock test connector, wireless foot controller, remote control, 2 carrying bags, IEC cable, stand
- Safety eye

LED PAR

- Lux@2m: 1205
- Colors: RGB
- LED: 6x3W 3-in-1
- Current: 950mA
- Beam angle: 24°

Derby

- Colors: RGB
- LED: 6x2W 3-in-1
- Current: 600mA

Laser

- Laser Class: 3B
- Laser Safety: EN/IEC 60825-1 Ed 2, 2007-03
- Laser Color: Red, Green
- Laser Power: 200mW (150mW 650nm Red, 50mW 532nm Green)
- Safety Features: Key switch, Interlock connector
- The laser only works when the interlock connector is connected and the key switch is turned

Strobe

- LED: 4x 1W White
- Current: 300mA
- Strobe: 0 – 18Hz

Footswitch

- Frequency: 433mHz
- Range: 30m

Tripod stand

- Height: 1,5 – 2,5m
- Footspace: 0,9m

Frontside

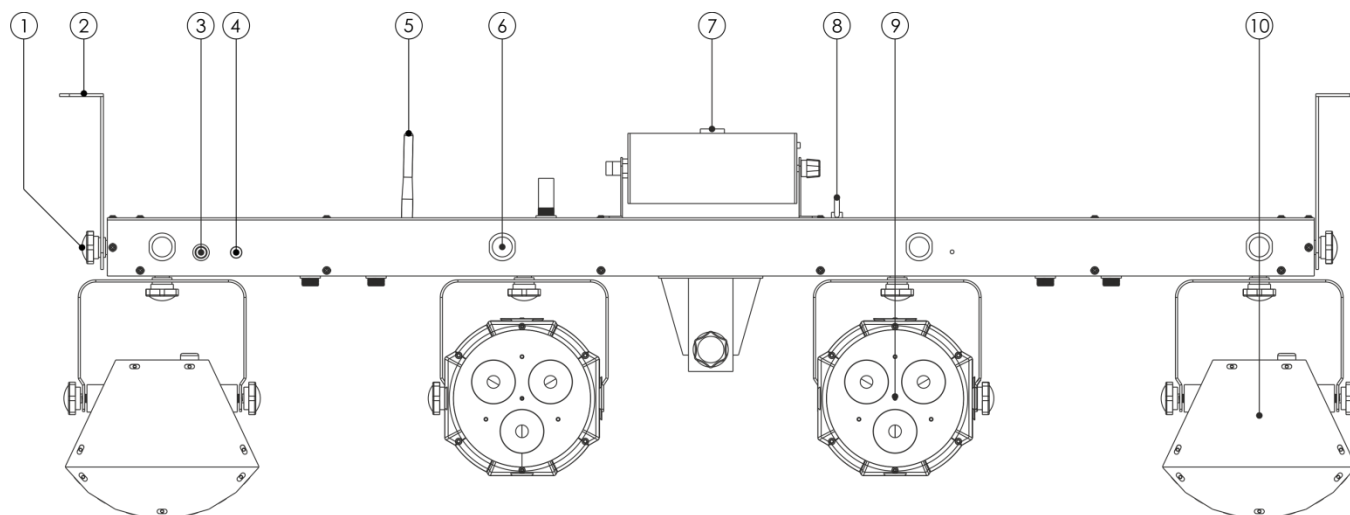

Fig. 01

- 01) Adjustment screw
- 02) Mounting bracket
- 03) Built-in microphone
- 04) IR sensor
- 05) Antenna for footswitch
- 06) 1W white LED
- 07) Laser
- 08) Safety eye
- 09) LED PAR
- 10) Derby

Backside

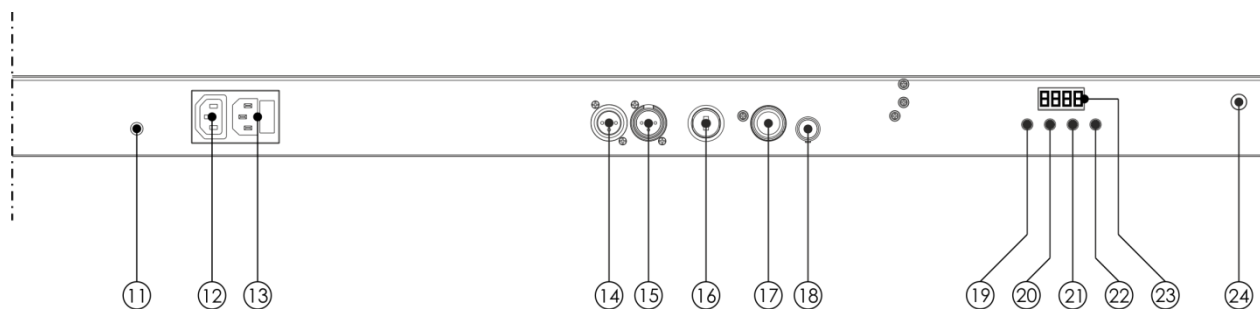
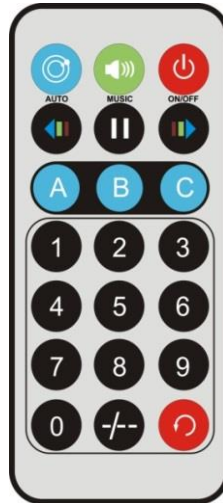

Fig. 02

- 11) Ground / earth connection
- 12) IEC Power connector (OUT)
- 13) IEC Power connector (IN), Fuse T1,5AL / 250V
- 14) 3-pin DMX signal connector OUT
- 15) 3-pin DMX signal connector IN
- 16) Key switch
- 17) Remote switch
- 18) Sound sensitivity
- 19) Mode button
- 20) Up button
- 21) Down button
- 22) Enter button
- 23) LCD display
- 24) IR sensor

Remote Control



Button	Function	Description
	On / Off	Power on / off
	Auto Mode	Set the auto mode from (AM01 - AM03)
	Sound Mode	Set the sound mode from (SN01 - SN03)
	PAR Auto Mode	Set the PAR mode from (AP01 - AP18)
	Laser Auto Mode	Set the laser mode (AL01 - AL06)
	Flash Auto Mode	Set the flash mode (AF01 - AF10)
	Auto / Sound switching	Switch between auto / sound ()
	Pause	pause
	Color changing	Select the PAR color
	Numeric keys	Program speed adjustment (1-9)

Attention:

Any control or setting with the remote control will be saved, until the system is rebooted.

Footswitch

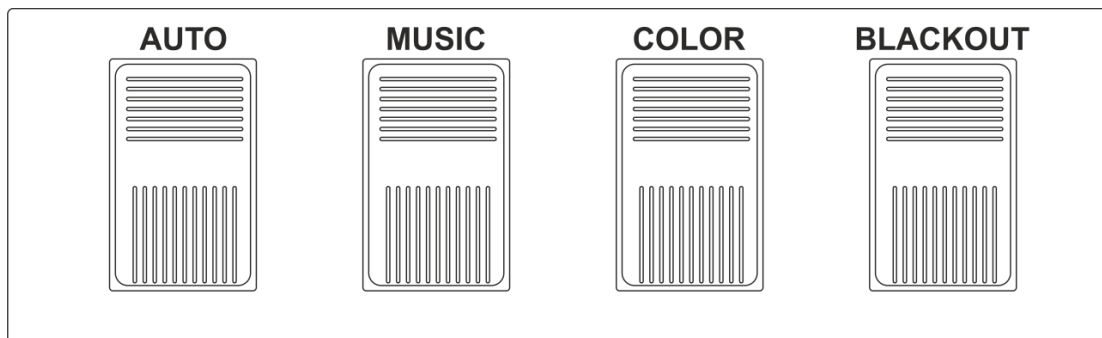

Button	Function	Description
Auto	Auto Mode	Set the auto mode from (AM01 - AM03)
Music	Sound Mode	Set the sound mode from (SM01 - SM03)
Color	Color changing	Select the PAR color
Blackout	Blackout	Blackout

Installation

Remove all packing materials from the QFX Compact Light FX Set. Check if all foam and plastic padding is removed. Connect all cables.

Do not supply power before the whole system is set up and connected properly.

Always disconnect from electric mains power supply before cleaning or servicing.

Damages caused by non-observance are not subject to warranty.

Set Up and Operation

Follow the directions below, as they pertain to your preferred operation mode.

Before plugging the unit in, always make sure that the power supply matches the product specification voltage. Do not attempt to operate a 120V specification product on 230V power, or vice versa.

Connect the device to the main power supply. The device can be music-controlled by its built-in microphone.

The Interlock plug/remote plug and safety keys are included in the box.

The interlock is the "included-in-the-box" successor for the optional remote interlock (51316)

⚠ They should be kept with the QFX Compact Light FX Set laser !!! ⚠

The following safety precautions should be followed:

- The keys should be put into the lock of your QFX Compact Light FX Set laser.

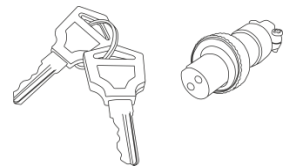

⚠ Warning ⚠

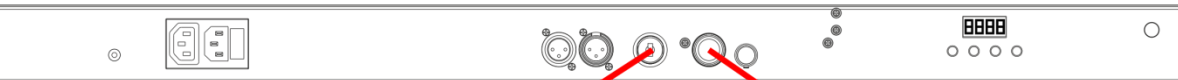

Exclusion of liability

Be aware that in some countries, there are additional regulations, regarding the use of laser devices. Therefore, we strongly advise you to verify your national laws with your authorities: We do not take any responsibility for eventual discrepancies, changes or adaptations regarding lawful use of laser devices.

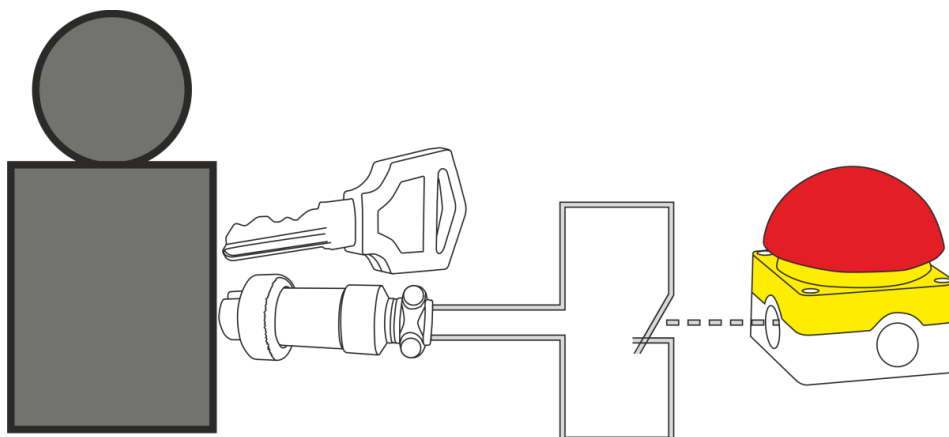

Control Modes

There are 5 modes:

- Built-in programs
- Sound-controlled
- Manual Mode
- Master / Slave
- DMX512

One QFX Compact Light FX Set (Built-in programs)

- 01) Fasten the effect light onto firm trussing. Leave at least 1 meter on all sides for air circulation.
- 02) Always use a safety cable (ordercode 70140 / 70141).
- 03) Plug the end of the electric mains power cord into a proper electric power supply socket.
- 04) When the QFX Compact Light FX Set is not connected by a DMX-cable, it functions as a stand-alone device.
- 05) Please see page 19 and 20 for more information about the Built-in auto programs.

One QFX Compact Light FX Set (Sound-controlled)

- 01) Fasten the effect light onto firm trussing. Leave at least 1 meter on all sides for air circulation.
- 02) Always use a safety cable (ordercode 70140 / 70141).
- 03) Plug the end of the electric mains power cord into a proper electric power supply socket.
- 04) When the QFX Compact Light FX Set is not connected with a DMX-cable, it functions as a stand-alone device.
- 05) Please see page 20 and 21 for more information about the Sound-controlled mode.

One QFX Compact Light FX Set (Manual Mode)

- 01) Fasten the effect light onto firm trussing. Leave at least 1 meter on all sides for air circulation.
- 02) Always use a safety cable (ordercode 70140 / 70141).
- 03) Plug the end of the electric mains power cord into a proper electric power supply socket.
- 04) When the QFX Compact Light FX Set is not connected with a DMX-cable, it functions as a stand-alone device.
- 05) Please see page 21 for more information about the Manual Mode.

Multiple QFX Compact Light FX Sets (Master/Slave Mode)

- 01) Fasten the effect light onto firm trussing. Leave at least 1 meter on all sides for air circulation.
- 02) Always use a safety cable (ordercode 70140 / 70141).
- 03) Plug the end of the electric mains power cord into a proper electric power supply socket.
- 04) Use a 3-pin XLR cable to connect the QFX Compact Light FX Sets.

The pins:



- 01) Earth
- 02) Signal (-)
- 03) Signal (+)

- 05) Link the units as shown in Fig. 03, connect a DMX signal cable from the first unit's DMX "out" socket to the second unit's "in" socket. Repeat this process to link the second, third, and fourth units. You can use the same functions on the master device as described on page 19, 20 and 21 (Built-in or Sound-controlled). This means on the master device you can set your desired operation Mode and all slave devices will react the same as the master device.

Multiple QFX Compact Light FX Sets Master / Slave Set Up

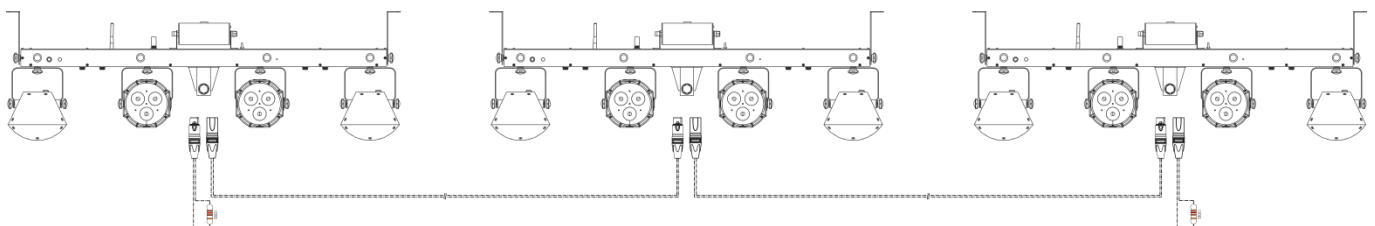
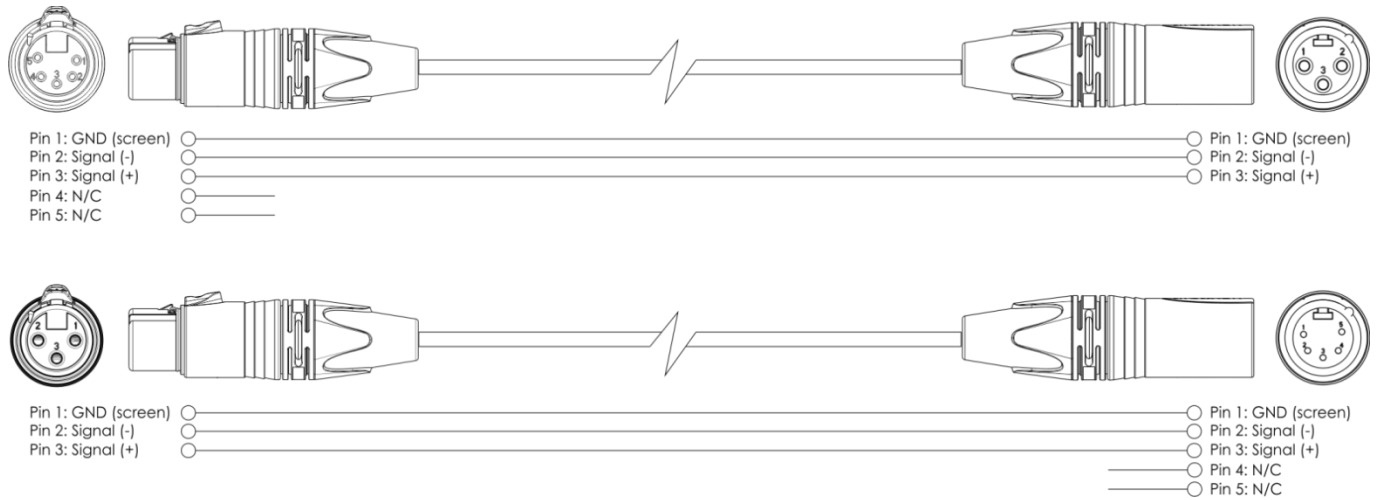

Fig. 03

Multiple QFX Compact Light FX Sets (DMX Control)

- 01) Fasten the effect light onto firm trussing. Leave at least 1 meter on all sides for air circulation.
- 02) Always use a safety cable (ordercode 70140 / 70141).
- 03) Plug the end of the electric mains power cord into a proper electric power supply socket.
- 04) Use a 3-p XLR cable to connect the QFX Compact Light FX Sets and other devices.



- 05) Link the units as shown in Fig. 04, Connect a DMX signal cable from the first unit's DMX "out" socket to the second unit's "in" socket. Repeat this process to link the second, third, and fourth units.
- 06) Supply electric power: Plug electric mains power cords into each unit's IEC socket, then plug the other end of the mains power cord into proper electric power supply sockets, starting with the first unit. Do not supply power before the whole system is set up and connected properly.

Multiple QFX Compact Light FX Sets DMX Set Up

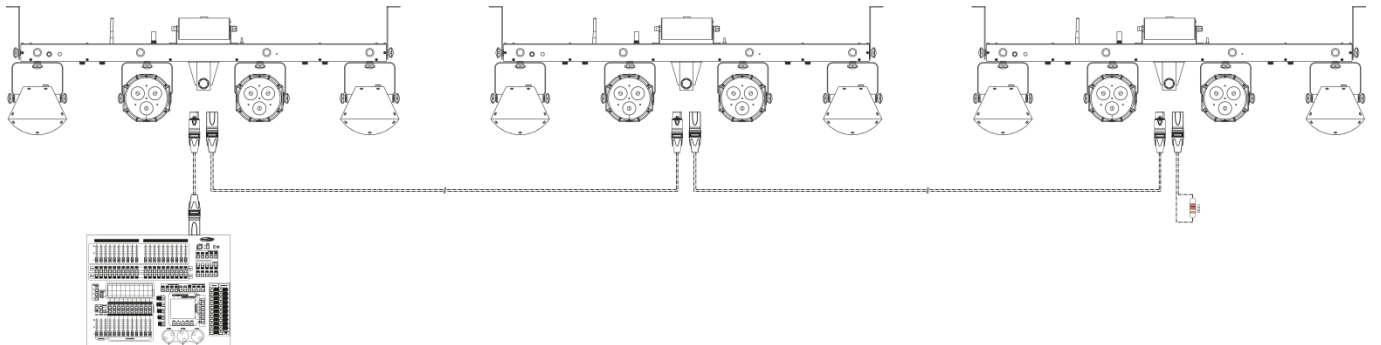

Fig. 04

Note: Link all cables before connecting electric power

Fixture Linking

You will need a serial data link to run light shows of one or more fixtures using a DMX-512 controller or to run synchronized shows on two or more fixtures set to a master/slave operating mode. The combined number of channels required by all the fixtures on a serial data link determines the number of fixtures the data link can support.

Important: Fixtures on a serial data link must be daisy chained in one single line. To comply with the EIA-485 standard no more than 30 devices should be connected on one data link. Connecting more than 30 fixtures on one serial data link without the use of a DMX optically isolated splitter may result in deterioration of the digital DMX signal.



Maximum recommended DMX data link distance: 100 meters

Maximum recommended number of fixtures on a DMX data link: 30 fixtures

Data Cabling

To link fixtures together, you must obtain data cables. You can purchase DAP Audio certified DMX cables directly from a dealer/distributor or construct your own cable. If you choose to create your own cable please use data-grade cables that can carry a high quality signal and are less prone to electromagnetic interference.

DAP Audio Certified DMX Data Cables

- DAP Audio cable for all-round use. bal. XLR/M 3 p. > XLR/F 3 p.
Ordercode FL01150 (1,5m.), FL013 (3m.), FL016 (6m.), FL0110 (10m.), FL0115 (15m.), FL0120 (20m.).
- DAP Audio cable for the demanding user with exceptional audio-qualities and connector made by Neutrik®. Ordercode FL71150 (1,5m.), FL713 (3m.), FL716 (6m.), FL7110 (10m.).

Control Panel

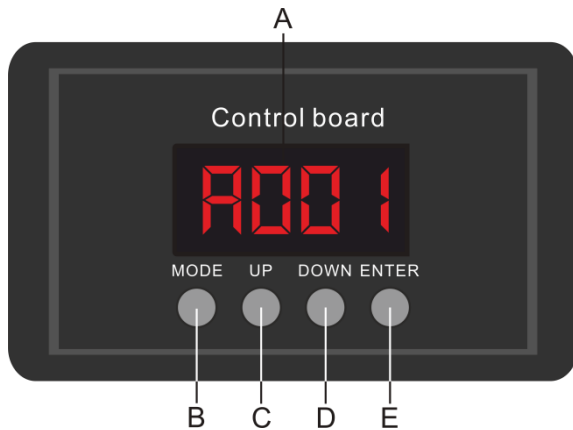

- A) LED display
- B) MODE button
- C) UP button
- D) DOWN button
- E) ENTER button

Fig. 05

Control Mode

The fixtures are individually addressed on a data-link and connected to the controller. The fixtures respond to the DMX signal from the controller (when you select the DMX address and save it, the controller will display the saved DMX address the next time).

DMX Addressing

The control panel on the front side of the base allows you to assign the DMX fixture address, which is the first channel from which the QFX Compact Light FX Set will respond to the controller.

Please note when you use the controller, the unit has **27** channels.

When using multiple QFX Compact Light FX Sets, make sure you set the DMX addresses right.

Therefore, the DMX address of the first QFX Compact Light FX Set should be **1(001)**; the DMX address of the second QFX Compact Light FX Set should be **1+27=28 (28)**; the DMX address of the third QFX Compact Light FX Set should be **28+27=55 (55)**, etc.

Please, be sure that you do not have any overlapping channels in order to control each QFX Compact Light FX Set correctly.

If two or more QFX Compact Light FX Sets are addressed similarly, they will work similarly.

Controlling:

After having addressed all QFX Compact Light FX Set fixtures, you may now start operating these via your lighting controller.

Note: After switching on, the QFX Compact Light FX Set will automatically detect whether DMX-512 data is received or not. If there is no data received at the DMX-input, the "**LED**" on the control panel will not flash.

The problem may be:

- The XLR cable from the controller is not connected with the input of the QFX Compact Light FX Set.
- The controller is switched off or defective, the cable or connector is defective, or the signal wires are swapped in the input connector.

Note: It is necessary to insert an XLR termination plug (with 120 Ohm) in the last fixture in order to ensure proper transmission on the DMX data link.

Menu Overview

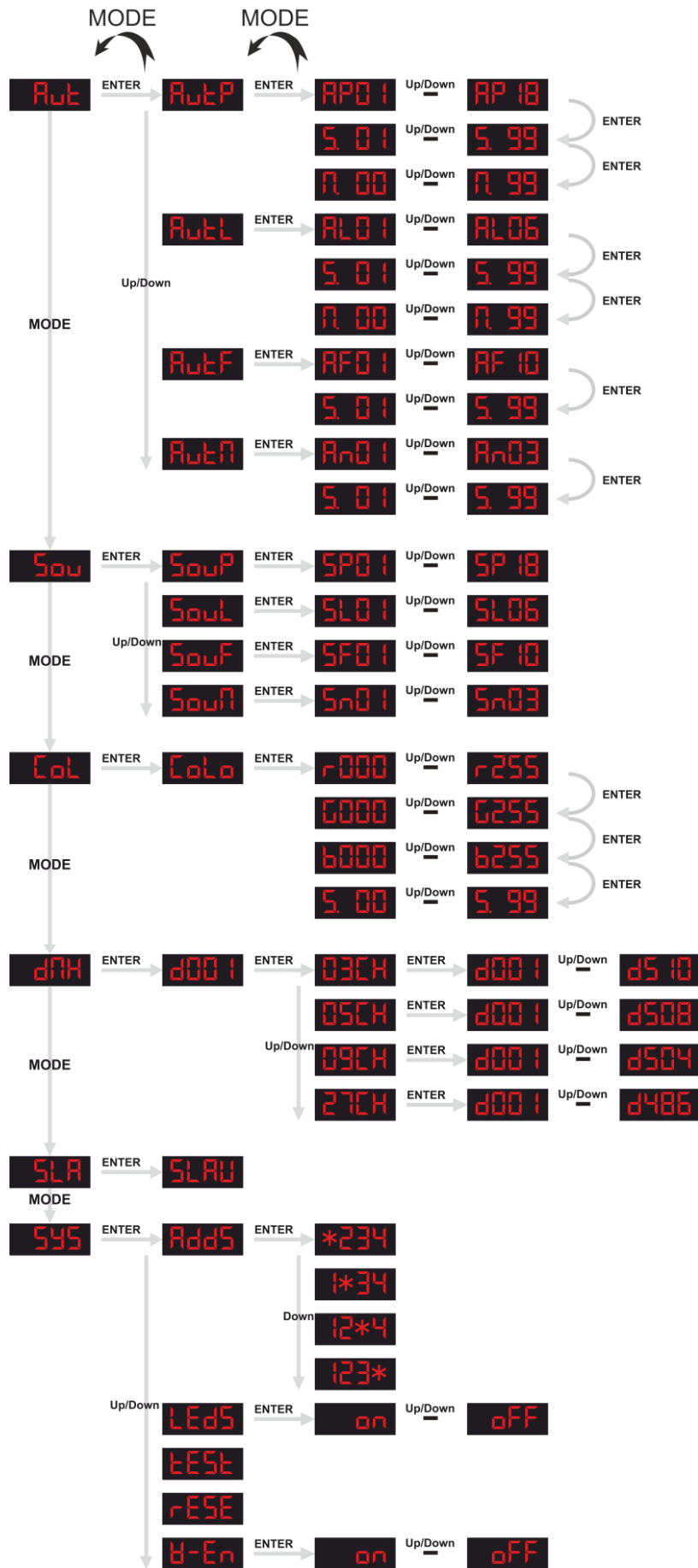

Main Menu Options

Aut	Built-in Programs
Sou	Sound-controlled
Col	Manual Mode
dMx	DMX Mode
SLA	Master / Slave Mode
SYS	Settings

V 100 The QFX Compact Light FX Set will only show its version number at start-up !

1. Built-in Programs

With this menu you can you can set the built-in programs.

- 01) Press the **MODE** button on the device, until the display shows **Aut**.
- 02) Press the **ENTER** button to open this menu.



- 03) You can use the Up / Down buttons to scroll through the 4 built-in programs.

AutP	PAR / Derby mode
AutL	Laser mode
AutF	Flash mode
AutN	Mix mode

1.1 PAR / Derby mode

- 01) Use the Up / Down buttons to choose a mode **AutP**.
- 02) You can use the **ENTER** button to change the settings.
- 03) Use the Up / Down buttons to change the PAR / Derby mode from **AP 01** Up/Down **AP 18**.
- 04) You can use the **ENTER** button to change the settings.
- 05) Use the Up / Down buttons to change the strobe speed from **5.01** Up/Down **5.99**.
- 06) You can use the **ENTER** button to change the settings.
- 07) Use the Up / Down buttons to change the motor speed from **n.00** Up/Down **n.99**.

1.2 Laser mode

- 01) Use the Up / Down buttons to choose a mode **AL0L**.
- 02) You can use the **ENTER** button to change the settings.
- 03) Use the Up / Down buttons to change the Laser mode from **AL01** Up/Down **AL06**.
- 04) You can use the **ENTER** button to change the settings.
- 05) Use the Up / Down buttons to change the strobe speed from **5.01** Up/Down **5.99**.
- 06) You can use the **ENTER** button to change the settings.
- 07) Use the Up / Down buttons to change the motor speed from **7.00** Up/Down **7.99**.

1.3 Flash mode

- 01) Use the Up / Down buttons to choose a mode **AL0F**.
- 02) You can use the **ENTER** button to change the settings.
- 03) Use the Up / Down buttons to change the Flash mode from **AF01** Up/Down **AF10**.
- 04) You can use the **ENTER** button to change the settings.
- 05) Use the Up / Down buttons to change the strobe speed from **5.01** Up/Down **5.99**.

1.4 Mix mode

- 01) Use the Up / Down buttons to choose a mode **AL0M**.
- 02) You can use the **ENTER** button to change the settings.
- 03) Use the Up / Down buttons to change the Mix mode from **AM01** Up/Down **AM03**.
- 04) You can use the **ENTER** button to change the settings.
- 05) Use the Up / Down buttons to change the strobe speed from **5.01** Up/Down **5.99**.

2. Sound-controlled

With this menu you can you can set the device to sound-control.

- 01) Press the **MODE** button on the device, until the display shows **Sou**.
- 02) Press the **ENTER** button to open this menu.



- 03) You can use the Up / Down buttons to scroll through the 4 sound-controlled programs.

- SouP** PAR / Derby mode
- SouL** Laser mode
- SouF** Flash mode
- SouM** Mix mode

2.1 PAR / Derby mode

- 01) Use the Up / Down buttons to choose **SouP**.
- 02) You can use the **ENTER** button to change the settings.
- 03) Use the Up / Down buttons to change the PAR / Derby mode from **SP01** Up/Down **SP18**.

2.2 Laser mode

- 01) Use the Up / Down buttons to choose **SouL**.
- 02) You can use the **ENTER** button to change the settings.
- 03) Use the Up / Down buttons to change the Laser mode from **SL01** Up/Down **SL06**.

2.3 Flash mode

- 01) Use the Up / Down buttons to choose **50wF**.
- 02) You can use the **ENTER** button to change the settings.
- 03) Use the Up / Down buttons to change the Flash mode from **5F01**  **5F10**.













2.4 Mix mode

- 01) Use the Up / Down buttons to choose **50wM**.
- 02) You can use the **ENTER** button to change the settings.
- 03) Use the Up / Down buttons to change the Mix mode from **5m01**  **5m03**.

3. Manual Mode

With this menu you can manually set a desired color.

- 01) Press the **MODE** button on the device, until the display shows **Col**.
- 02) Press the **ENTER** button to open the **Colo** menu.
- 03) You can use the **ENTER** button to scroll through the 3 color options and set the speed.





			Set the value of the red LEDs (000-255).
			Set the value of the green LEDs (000-255).
			Set the value of the blue LEDs (000-255).
			Set the strobe speed (00-99).

- 04) Use the Up / Down buttons to change the values.
You can combine Red, Green and Blue to create an infinite range of colors (000-255).













4. DMX Mode

With this menu you can select the DMX mode, and set the DMX address.

- 01) Press the **MODE** button on the device, until the display shows **DMX**.
- 02) Press the **ENTER** button to open the **d001** menu.
- 03) Press the **ENTER** button to open this menu.

	The QFX Compact Light Set has 4 different DMX modes.
	
	
	

- 04) You can use the Up / Down buttons to scroll through the 4 programs.
- 05) You can use the **ENTER** button to select a DMX mode, and set the DMX address.

			Set the address from d001-d510 (03CH).
			Set the address from d001-d508 (05CH).
			Set the address from d001-d504 (09CH).
			Set the address from d001-d486 (27CH).

- 06) Use the Up / Down buttons to change the values.





5. Master / Slave Mode















- 01) Use the Up / Down buttons to choose a mode **SLA**.
- 02) You can use the **ENTER** button to set the QFX Compact Light FX Set to **SLAV**.

6. Settings

With this menu you can you can enter the settings.

- 01) Press the **MODE** button on the device, until the display shows .
- 02) Press the **ENTER** button to open this menu.

	Machine Position Setting
	Display On / Off
	Test Mode
	Factory Reset
	Wireless Pedal On / Off

- 03) You can use the Up / Down buttons to scroll through the 5 settings.
- 04) You can use the **ENTER** button to change the machine position settings .
- 05) Use the Up / Down buttons to change the PAR and Derby order.
The PAR and Derby can be changed in every order , , , .
- 06) You can use the **ENTER** button to select the display on / off function .
- 07) Use the Up / Down buttons to set the display on / off function   .
- If switched on, the display will turn off after 30sec.
- 08) You can use the **ENTER** button to select the test mode .
- 09) You can use the **ENTER** button to confirm.
- 10) You can use the **ENTER** button to select the factory reset .
- 11) You can use the **ENTER** button to confirm.
- 12) You can use the **ENTER** button to select the wireless pedal on / off function .
- 13) Use the Up / Down buttons to set the wireless pedal on / off function   .

DMX Channels

3 Channels

Channel 1 – Built-in Programs (CH2 must be set between 001-255)

0-9	Blackout
10-31	Auto PAR
32-65	Auto Laser
66-95	Auto Flash LED
96-127	Auto MIX
128-159	Sound PAR
160-191	Sound Laser
192-223	Sound Flash LED
223-255	Sound MIX

Channel 2 – Auto PAR (CH1 must be set between 010-031)

0	Blackout
1-9	AP01
10-19	AP02
20-29	AP03
30-39	AP04
40-49	AP05
50-59	AP06
60-69	AP07
70-79	AP08
80-89	AP09
90-99	AP10

100-109	AP11
110-119	AP12
120-129	AP13
130-139	AP14
140-149	AP15
150-159	AP16
160-169	AP17
170-255	AP18

Channel 2 – Auto Laser (CH1 must be set between 032-065)

0-39	AL01
40-79	AL02
80-119	AL03
120-139	AL04
140-159	AL05
160-255	AL06

Channel 2 – Auto Flash LED (CH1 must be set between 066-095)

0-14	AF01
15-29	AF02
30-44	AF03
45-59	AF04
60-74	AF05
75-89	AF06
90-104	AF07
105-119	AF08
120-134	AF09
135-255	AF10

Channel 2 – Auto MIX (CH1 must be set between 096-127)

0-19	AM01
20-39	AM02
40-255	AM03

Channel 2 – Sound PAR (CH1 must be set between 128-159)

0-9	SP01
10-19	SP02
20-29	SP03
30-39	SP04
40-49	SP05
50-59	SP06
60-69	SP07
70-79	SP08
80-89	SP09
90-99	SP10
100-109	SP11
110-119	SP12
120-129	SP13
130-139	SP14
140-149	SP15
150-159	SP16
160-169	SP17
170-255	SP18

Channel 2 – Sound Laser (CH1 must be set between 160-191 )

0-39	SL01
40-79	SL02
80-119	SL03
120-139	SL04
140-159	SL05
160-255	SL06

Channel 2 – Sound Flash LED (CH1 must be set between 192-223 )

0-14	SF01
15-29	SF02
30-44	SF03
45-59	SF04
60-74	SF05
75-89	SF06
90-104	SF07
105-119	SF08
120-134	SF09
135-255	SF10

Channel 2 – Sound MIX (CH1 must be set between 224-255 )

0-19	SM01
20-39	SM02
40-255	SM03

Channel 3 – Program Speed (CH1 must be set between 010-255, CH2 must be set between 001-255 )

0-255	From slow to fast, 0 is the slowest, 255 is the fastest
-------	---

5 Channels**Channel 1 – PAR and Derby Red Dimmer intensity (CH4 must be set between 001-255 )**

0-255	Red from 0 – 100%
-------	-------------------

Channel 2 – PAR and Derby Green Dimmer intensity (CH4 must be set between 001-255 )

0-255	Green from 0 – 100%
-------	---------------------

Channel 3 – PAR and Derby Blue Dimmer intensity (CH4 must be set between 001-255 )

0-255	Blue from 0 – 100%
-------	--------------------

Channel 4 – PAR and Derby Dimmer intensity (CH1, CH2 or CH3 must be set between 001-255 )

0-191	Brightness of all lights
192-200	Sound strobe
201-249	Strobe effect, from slow to fast (0-18Hz)
250-255	Full on

Channel 5 – Derby LED Motor rotating speed

0-4	Stop
5-127	Rotate clockwise, from slow to fast
128-133	Stop
134-255	Rotate counterclockwise, from slow to fast

9 Channels

Channel 1 – PAR and Derby Red Dimmer intensity (CH4 must be set between 001-255 )
0-255 Red from 0 – 100%

Channel 2 – PAR and Derby Green Dimmer intensity (CH4 must be set between 001-255 )
0-255 Green from 0 – 100%

Channel 3 – PAR and Derby Blue Dimmer intensity (CH4 must be set between 001-255 )
0-255 Blue from 0 – 100%

Channel 4 – PAR and Derby Dimmer intensity (CH1, CH2 or CH3 must be set between 001-255 )
0-191 Brightnes of all lights
192-200 Sound strobe
201-249 Strobe effect, from slow to fast (0-18Hz)
250-255 Full on

Channel 5 – Derby LED Motor rotating speed

0-4 Stop
5-127 Rotate clockwise, from slow to fast
128-133 Stop
134-255 Rotate counterclockwise, from slow to fast

Channel 6 – Red Laser Dimmer intensity

0-4 Blackout
5-9 Full on
10-255 Strobe effect, from slow to fast (0-18Hz)

Channel 7 – Red Laser Dimmer intensity

0-4 Blackout
5-9 Full on
10-255 Strobe effect, from slow to fast (0-18Hz)

Channel 8 – Laser Motor rotating speed

0-4 Stop
5-127 Rotate clockwise, from slow to fast
128-133 Stop
134-255 Rotate counterclockwise, from slow to fast

Channel 9 – 4 pcs Strobe LED

0-4 Blackout
5-9 Full on
10-255 Strobe effect, from slow to fast (0-18Hz)

27 Channels

Channel 1 – Derby (nr.1) Red Dimmer intensity

0-255 Red from 0 – 100%

Channel 2 – Derby (nr.1) Green Dimmer intensity

0-255 Green from 0 – 100%

Channel 3 – Derby (nr.1) Blue Dimmer intensity

0-255 Blue from 0 – 100%

Channel 4 – Derby (nr.1) Speed

0-9 Blackout

10-255 Strobe effect, from slow to fast (0-18Hz)

Channel 5 – Derby (nr.1) Motor rotating speed

0-4 Stop

5-127 Rotate clockwise, from slow to fast

128-133 Stop

134-255 Rotate counterclockwise, from slow to fast

Channel 6 – PAR (nr.2) Red Dimmer intensity

0-255 Red from 0 – 100%

Channel 7 – PAR (nr.2) Derby Green Dimmer intensity

0-255 Green from 0 – 100%

Channel 8 – PAR nr.2 Derby Blue Dimmer intensity

0-255 Blue from 0 – 100%

Channel 9 – PAR (nr.2) Speed

0-9 Blackout

10-255 Strobe effect, from slow to fast (0-18Hz)

Channel 10 – PAR (nr.2)

0-255 Keep the channel

Channel 11 – PAR (nr.3) Red Dimmer intensity

0-255 Red from 0 – 100%

Channel 12 – PAR (nr.3) Derby Green Dimmer intensity

0-255 Green from 0 – 100%

Channel 13 – PAR (nr.3) Derby Blue Dimmer intensity

0-255 Blue from 0 – 100%

Channel 14 – PAR (nr.3) Speed

0-9 Blackout

10-255 Strobe effect, from slow to fast (0-18Hz)

Channel 15 – PAR (nr.3)

0-255 Keep the channel

Channel 16 – Derby (nr.4) Red Dimmer intensity

0-255 Red from 0 – 100%

Channel 17 – Derby (nr.4) Green Dimmer intensity

0-255 Green from 0 – 100%

Channel 18 – Derby (nr.4) Blue Dimmer intensity

0-255 Blue from 0 – 100%

Channel 19 – Derby (nr.4) Speed

0-9 Blackout

10-255 Strobe effect, from slow to fast (0-18Hz)

Channel 20 – Derby (nr.4) Motor rotating speed

0-4 Stop

5-127 Rotate clockwise, from slow to fast

128-133 Stop

134-255 Rotate counterclockwise, from slow to fast

Channel 21 – Red Laser Dimmer intensity

0-4 Blackout

5-9 Full on

10-255 Strobe effect, from slow to fast (0-18Hz)

Channel 22 – Green Laser Dimmer intensity

0-4 Blackout

5-9 Full on

10-255 Strobe effect, from slow to fast (0-18Hz)

Channel 23 – Laser Motor rotating speed

0-4 Stop

5-127 Rotate clockwise, from slow to fast

128-133 Stop

134-255 Rotate counterclockwise, from slow to fast

Channel 24 – Strobe LED (nr.1) Dimmer intensity

0-4 Blackout

5-9 Full on

10-255 Strobe effect, from slow to fast (0-18Hz)

Channel 25 – Strobe LED (nr.2) Dimmer intensity

0-4 Blackout

5-9 Full on

10-255 Strobe effect, from slow to fast (0-18Hz)

Channel 26 – Strobe LED (nr.3) Dimmer intensity

0-4 Blackout

5-9 Full on

10-255 Strobe effect, from slow to fast (0-18Hz)

Channel 27 – Strobe LED (nr.4) Dimmer intensity

0-4 Blackout

5-9 Full on

10-255 Strobe effect, from slow to fast (0-18Hz)

Maintenance

The Showtec QFX Compact Light FX Set requires almost no maintenance. However, you should keep the unit clean. Otherwise, the fixture's light-output will be significantly reduced.

Disconnect the mains power supply and then wipe the cover with a damp cloth. Wipe the front glass panel clean with glass cleaner and a soft cloth. Do not use alcohol or solvents. The front glass panel will require weekly cleaning, as smoke-fluid tends to build up residues, reducing the light-output very quickly. Do not immerse in liquid.

Keep connections clean. Disconnect electric power, and then wipe the DMX and audio connections with a damp cloth. Make sure connections are thoroughly dry before linking equipment or supplying electric power.

The operator has to make sure that safety-relating and machine-technical installations are to be inspected by an expert after every year in the course of an acceptance test.

The operator has to make sure that safety-relating and machine-technical installations are to be inspected by a skilled person once a year.

The following points have to be considered during the inspection:

- 01) All screws used for installing the device or parts of the device have to be tightly connected and must not be corroded.
- 02) There may not be any deformations on housings, fixations and installation spots.
- 03) Mechanically moving parts like axles, eyes and others may not show any traces of wearing.
- 04) The electric power supply cables must not show any damages or material fatigue.

Replacing the Fuse

Power surges, short-circuit or inappropriate electrical power supply may cause a fuse to burn out. If the fuse burns out, the product will not function whatsoever. If this happens, follow the directions below.

- 01) Unplug the unit from electric power source.
- 02) Insert a screwdriver into the slot in the fuse cover. Gently pry up the fuse cover. The fuse will come out.
- 03) Remove the used fuse. If brown or unclear, it is burned out.
- 04) Insert the replacement fuse into the holder where the old fuse was. Reinsert the fuse cover. Be sure to use a fuse of the same type and specification. See the product specification label for details.

Troubleshooting

No Light

This troubleshooting guide is meant to help solve simple problems.

If a problem occurs, carry out the steps below in sequence until a solution is found. Once the unit operates properly, do not carry out following steps.

If the light effect does not operate properly, refer servicing to a technician.

Response: Suspect three potential problem areas as: the power supply, the laser, the fuse.

01) Power supply. Check that the unit is plugged into an appropriate power supply.

02) The laser. Return the QFX Compact Light FX Set to your Showtec dealer.

03) The fuse. Replace the fuse. See page 28 for replacing the fuse.

04) If all of the above appears to be O.K., plug the unit in again.

05) If you are unable to determine the cause of the problem, do not open the QFX Compact Light FX Set, as this may damage the unit and the warranty will become void.

06) Return the device to your Showtec dealer.

No Response to DMX

Response: Suspect the DMX cable or connectors, a controller malfunction, a light effect DMX card malfunction.

01) Check the DMX setting. Make sure that DMX addresses are correct.

02) Check the DMX cable: Unplug the unit; change the DMX cable; then reconnect to electrical power. Try your DMX control again.

03) Determine whether the controller or light effect is at fault. Does the controller operate properly with other DMX products? If not, take the controller in for repair. If so, take the DMX cable and the light effect to a qualified technician.

Problem	Probable cause(s)	Remedy
One or more fixtures are completely dead.	No power to the fixture.	<ul style="list-style-type: none"> Check that power is switched on and cables are plugged in.
	Primary fuse blown..	<ul style="list-style-type: none"> Replace fuse.
Fixtures reset correctly, but all respond erratically or not at all to the controller.	The controller is not connected.	<ul style="list-style-type: none"> Connect controller.
	3-pin XLR Out of the controller does not match XLR Out of the first fixture on the link (i.e. signal is reversed).	<ul style="list-style-type: none"> Install a phase reversing cable between the controller and the first fixture on the link.
Fixtures reset correctly, but some respond erratically or not at all to the controller.	Poor data quality	<ul style="list-style-type: none"> Check data quality. If much lower than 100 percent, the problem may be a bad data link connection, poor quality or broken cables, missing termination plug, or a defective fixture disturbing the link.
	Bad data link connection	<ul style="list-style-type: none"> Inspect connections and cables. Correct poor connections. Repair or replace damaged cables.
	Data link not terminated with 120 Ohm termination plug.	<ul style="list-style-type: none"> Insert termination plug in output jack of the last fixture on the link.
	Incorrect addressing of the fixtures.	<ul style="list-style-type: none"> Check address setting.
	One of the fixtures is defective and disturbs data transmission on the link.	<ul style="list-style-type: none"> Bypass one fixture at a time until normal operation is regained: unplug both connectors and connect them directly together. Have the defective fixture serviced by a qualified technician.
	3-pin XLR Out on the fixtures does not match (pins 2 and 3 reversed).	<ul style="list-style-type: none"> Install a phase-reversing cable between the fixtures or swap pin 2 and 3 in the fixture, that behaves erratically.
Shutter closes suddenly	The laser diode has lost its index position and the fixture is resetting the effect.	<ul style="list-style-type: none"> Contact a technician for servicing the problem persists.
No light or laser cuts out intermittently	Fixture is too hot.	<ul style="list-style-type: none"> Allow fixture to cool. Make sure air vents at control panel and front lens are not blocked. Turn up the air conditioning .
	LEDs damaged	<ul style="list-style-type: none"> Disconnect fixture and return to your dealer.
	The power supply settings do not match local AC voltage and frequency.	<ul style="list-style-type: none"> Disconnect fixture. Check settings and correct if necessary.

Product Specifications

Model:	QFX Compact Light FX Set
Input Voltage:	AC 100-240V, 50/60Hz
Continuous Power:	45 Watt
Fuse:	T1,5A / 250V
Dimensions:	1185 x 110 x 387 mm (LxWxH)
Weight:	6,6 kg
Operation and Programming:	
Set Up and Addressing:	Red 4 Digits LED display for all settings
Power Connection:	IEC in- & output
DMX modes:	3, 5, 9, 27 Channels
Signal input:	3-pin DMX signal connector IN
Signal output:	3-pin DMX signal connector OUT
Signal pin OUT:	pin 1 earth, pin 2 (-), pin 3 (+)
Electro-mechanical effects:	
Control modes:	Built-in programs, Sound controlled, Manual mode, Master / Slave, DMX
Sound-control:	via built-in microphone
Housing:	Compact strong metal housing with safety eye
IP Rating:	IP20
Cooling:	Convection (no fans) which eliminates the use of fans and noise
Working temperature:	-10°C - 40°C
Included:	2 keys, Interlock test connector, wireless foot controller, remote control, 2 carrying bags, IEC cable, stand
LED PAR:	
Lux@2m:	1205
Colors:	RGB
LED:	6x3W 3-in-1
Current:	950mA
Beam angle:	24°
Derby:	
Colors:	RGB
LED:	6x2W 3-in-1
Current:	600mA
Laser:	
Laser Class:	3B
Laser Safety:	EN/IEC 60825-1 Ed 2, 2007-03
Laser Color:	Red, Green
Laser Power:	200mW (150mW 650nm Red, 50mW 532nm Green)
Safety Features:	Key switch, Interlock connector
Strobe:	
LED:	4x 1W White
Current:	300mA
Strobe:	0 – 18Hz
Footswitch:	
Frequency:	433mHz
Range:	30m
Tripod stand:	
Height:	1,5 – 2,5m
Footspace:	0,9m
Max. ambient temperature t_a : 40°C	Max. housing temperature t_a : 80°C

QFX Compact Light FX Set

Minimum distance:	
Minimum distance from flammable surfaces:	1 m
Minimum distance to lighted object:	1 m

Design and product specifications are subject to change without prior notice.



Website: www.Showtec.info

Email: service@highlite.nl

Dimensions

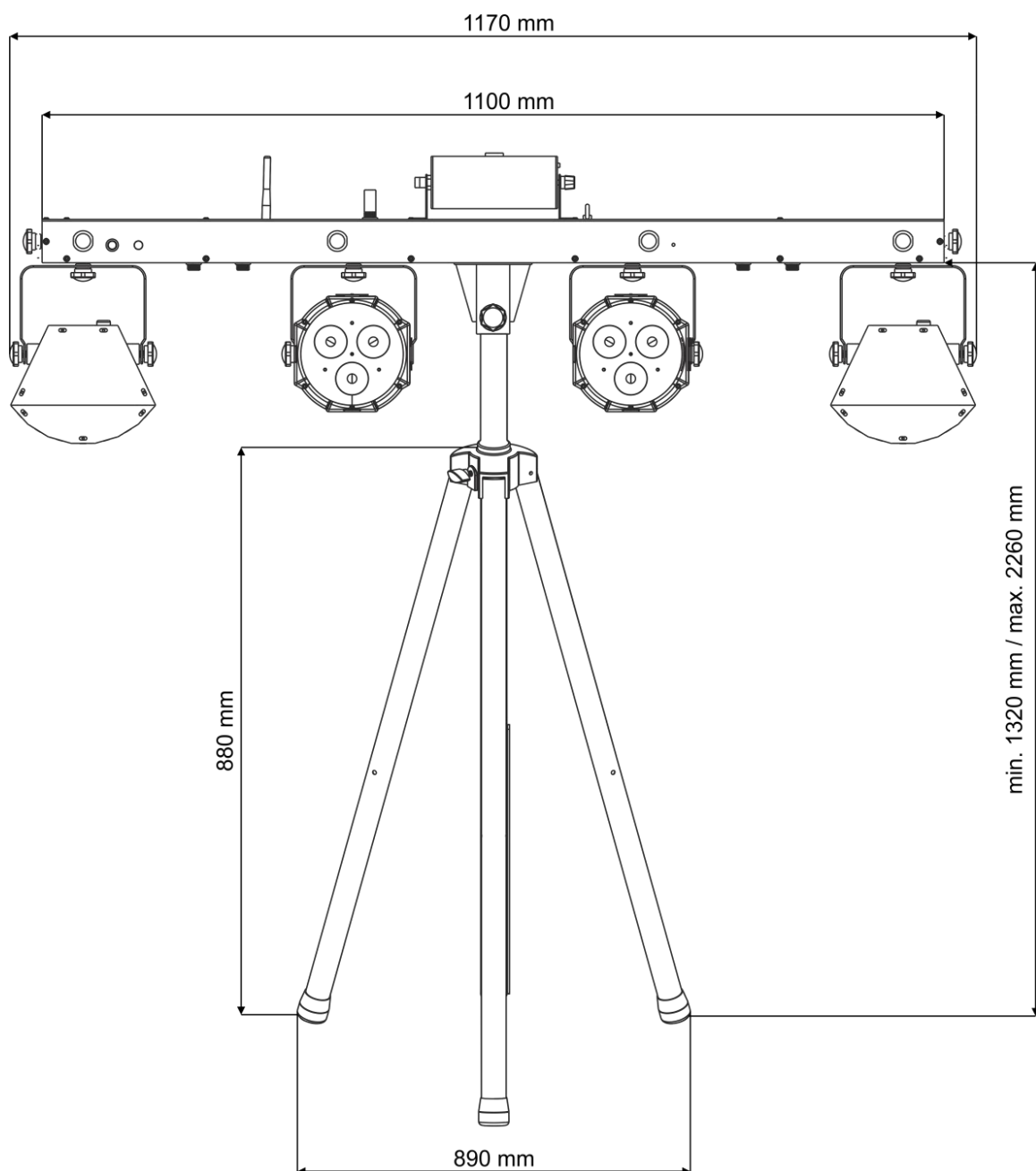

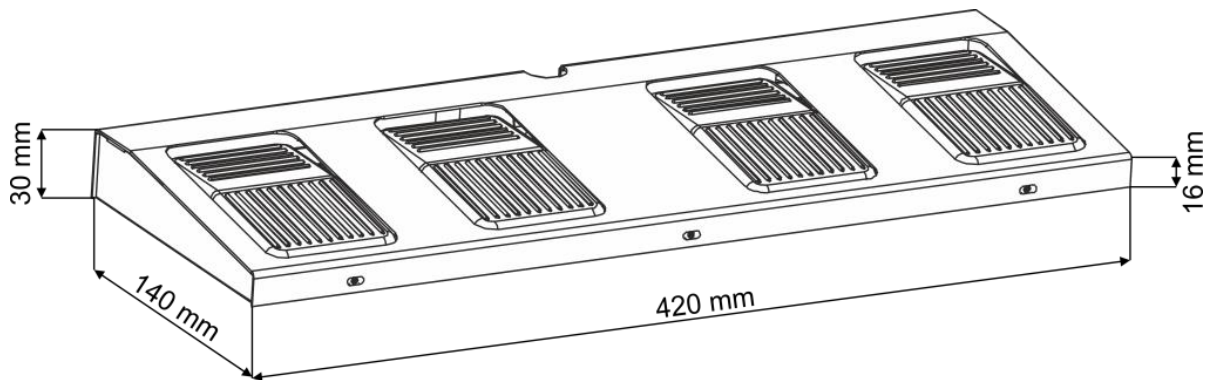
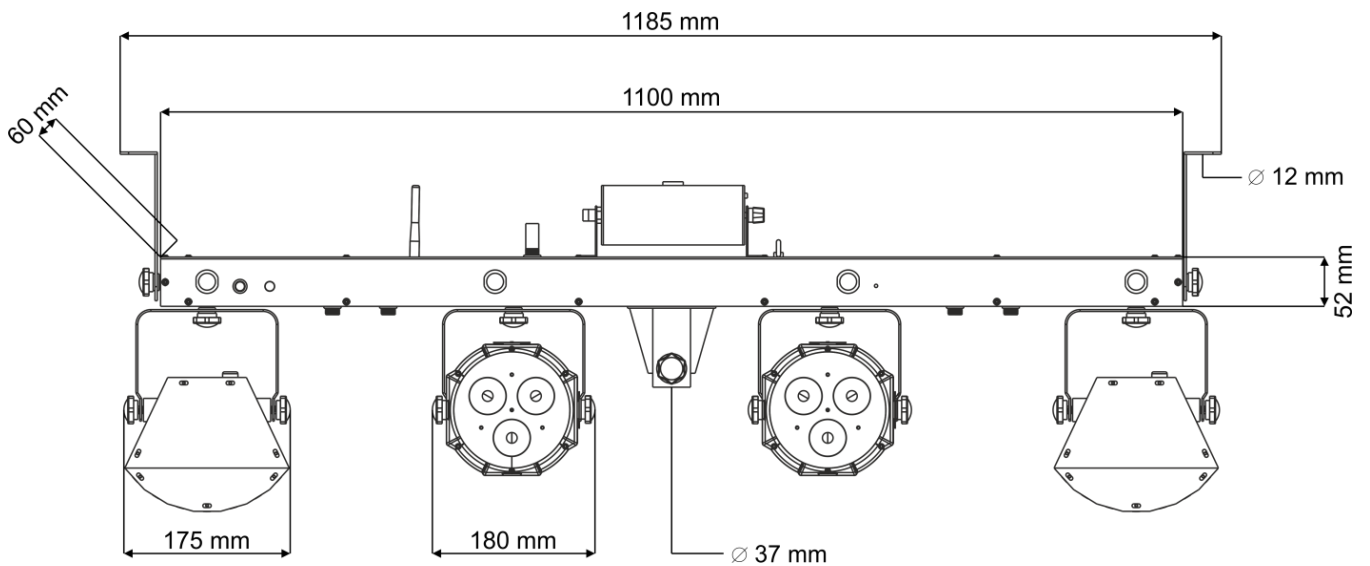
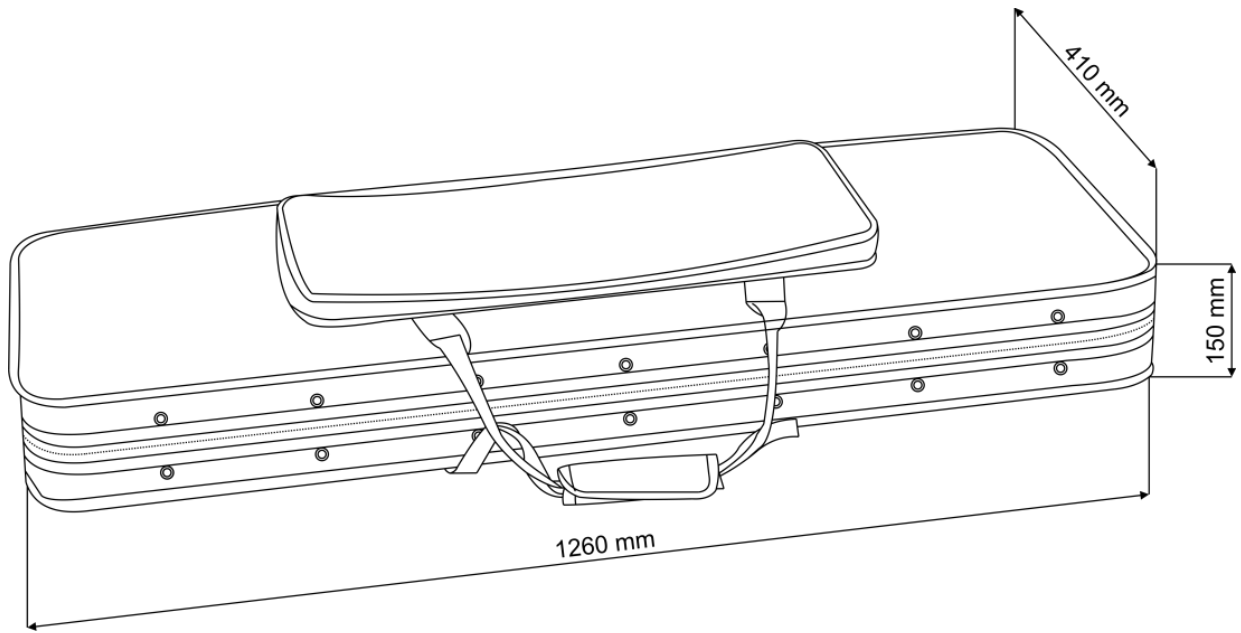



©2015 Showtec