

MOOSE

www.mooseaudio.com

PROUDLY DEVELOPED AND
MANUFACTURED IN PORTUGAL

M10, M12 & M15

Passive stage monitors

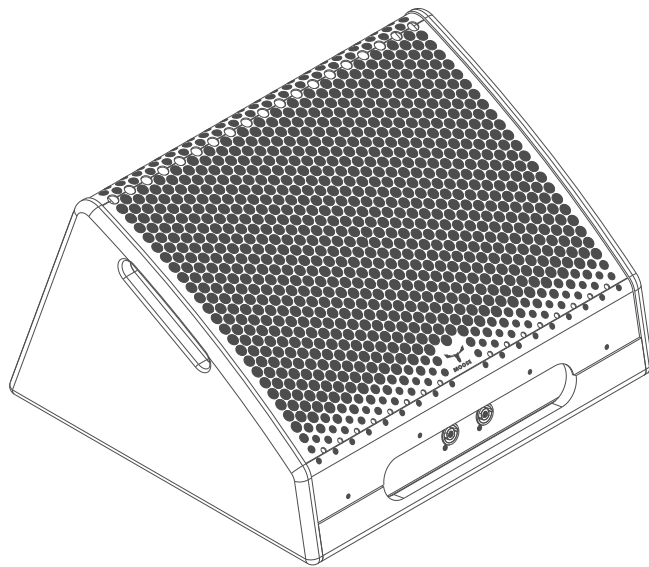

USER'S MANUAL

Introduction

Dear customer,

Thank for choosing MOOSE branded products!

MOOSE is a brand of professional audio & lighting products, proudly developed and manufactured in PORTUGAL.

In order to operate this product in a safe and reliable manner, please follow the instructions in this booklet and before operating the equipment read the instructions carefully and please note the technical information.

Our products undergo very rigorous testing under strict conditions and they are monitored continuously during the manufacturing process. In order to guarantee the product function and safety, the original parts of the manufacturer's design must be used. If any parts other than those of the manufacturer are used, or the product is modified in any way, the user forfeits all warranty rights to claim.

Caution

1. Before connecting the equipment to the power outlet, first verify that the mains voltage and frequency match the values specified on the equipment.
2. If the power cord of the device is equipped with an earthing contact, then it must be connected to an outlet with a protective ground. Never deactivate the protective ground of a power cord.
3. Unplug the power cord and power adapter from the power outlet if there is a risk of a lightning strike or before extended periods of disuse.
4. Replace fuses only with fuses of the same type and rating. If a fuse blows repeatedly, please contact an authorised service company.
5. Do not open or modify this equipment.
6. After connecting the equipment, check all cables in order to prevent damage or accidents, e.g., due to tripping hazards.
7. Do not turn on the Amplifier ON before checking that all volumes to zero .

IMPORTANT: Never remove the cover, because otherwise there may be a risk of electric shock. There are no user serviceable parts inside. Have repairs carried out only by qualified service personnel.



The lightning flash with arrowhead symbol within an equilateral triangle is intended to alert the user to the presence of uninsulated "dangerous voltage" within the product's enclosure that may be of sufficient magnitude to constitute a risk of electrical shock.



The exclamation mark within an equilateral triangle is intended to alert the user to the presence of important operating and maintenance instructions.



To prevent electrical shock do not remove the cover. No user serviceable parts inside. Refer service to qualified personnel only.

The amplifier is marked with this instruction so please proceed accordingly in order to avoid any hazard.

Manufacturers Declaration

PROPER DISPOSAL OF THIS PRODUCT

(Valid in the European Union and other European countries with waste separation)

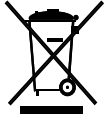

This symbol on the product, or the documents accompanying the product, indicates that this appliance may not be treated as household waste. This is to avoid environmental damage or personal injury due to uncontrolled waste disposal. Please dispose of this product separately from other waste and have it recycled to promote sustainable economic activity.

Household users should contact either the retailer where they purchased this product, or their local government office, for details on where and how they can recycle this item in an environmentally friendly manner.

Business users should contact their supplier and check the terms and conditions of the purchase contract. This product should not be mixed with other commercial wastes for disposal .

ENVIRONMENTAL PROTECTION AND ENERGY CONSERVATION

Energy conservation is an active contribution to environmental protection. Please turn off all unneeded electrical devices. To prevent unneeded devices from consuming power in standby mode, disconnect the mains plug.

EC DECLARATION OF CONFORMITY

The equipment marketed by MOOSE complies (where applicable) with the essential requirements and other relevant specifications of Directives 1999/5/EC (R&TTE), 2004/108/EC (EMC) und 2006/95/EC (LVD). Additional information can be requested to info@profactor.pt.



PROUDLY DEVELOPED AND MANUFACTURED IN PORTUGAL

Connections and Controls

Please refer to the following scheme and instructions:

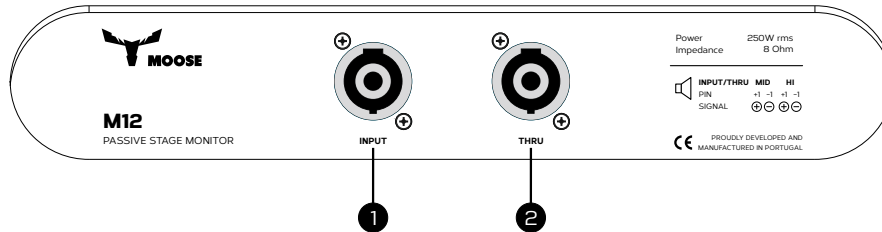

1. INPUT: Speakon compatible input.

2. THRU: Speakon compatible output (parallel wired with Speakon compatible input 1+/-).

Technical specifications

MODEL	M10	M12	M15
TYPE	2-way passive monitor	2-way passive monitor	2-way passive monitor
ENCLOSURE DESIGN	Wedged cabinet	Wedged cabinet	Wedged cabinet
	Bass reflex	Bass reflex	Bass reflex
POWER OUTPUT (RMS)	250W	350W	500W
FREQUENCY RANGE	80Hz - 19kHz	80Hz - 19kHz	80Hz - 19kHz
NOMINAL IMPEDANCE	80hm	80hm	80hm
TRANSDUCER TYPE	10" MF + 1" HF	12" MF + 1" HF	15" MF + 1" HF
DISPERSION	60°x40°	60°x40°	75°x35°
CROSSOVER FREQUENCY	N/A	N/A	N/A
MAX. S.P.L. (PEAK)	116dB @ 1m	121dB @ 1m	126dB @ 1m
CONSTRUCTION	15mm birch plywood	15mm birch plywood	15mm birch plywood
GRILLE	Custom perforated metal grille with protective foam		
INSTALLATION, RIGGING, FLYING	4 rubber feet	4 rubber feet	4 rubber feet
DIMENSIONS (WxDxH)	500x400x290mm	500x400x290mm	660x570x330mm
WEIGHT	15Kg	16.5Kg	20.5Kg

Dimensions

M10

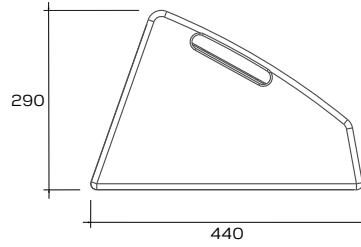
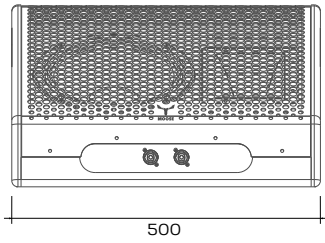

M12

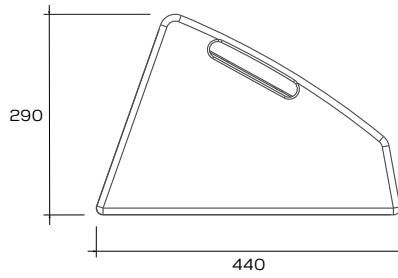
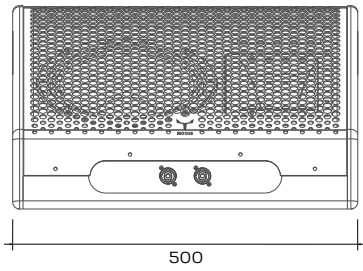

M15

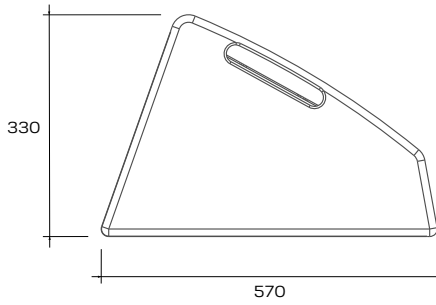
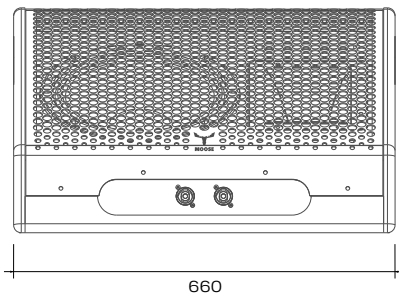

Unit: mm (millimeters)

PROFACTOR S.A., all rights reserved. The technical data and the functional product characteristics can be subject to modifications. The photocopying, the translation, and all other forms of copying of fragments or of the integrity of this user's manual is prohibited.

PROUDLY DEVELOPED AND
MANUFACTURED IN PORTUGAL

MOOSE is a brand of PROFACTOR S.A.

PROFACTOR S.A

Rua do Padrão 52
4440-617 Valongo
PORTUGAL
Telf.: +351 224 119 160
Fax: +351 224 155 822
info@profactor.pt

MOOSE



www.moosesound.com