

EUROPORT

EPA40



www.behringer.com

User Manual 

Version 1.0 April 2007



IMPORTANT SAFETY INSTRUCTIONS

CAUTION: To reduce the risk of electric shock, do not remove the top cover (or the rear section). No user serviceable parts inside; refer servicing to qualified personnel.



This symbol, wherever it appears, alerts you to the presence of uninsulated dangerous voltage inside the enclosure—voltage that may be sufficient to constitute a risk of shock.

WARNING: To reduce the risk of fire or electric shock, do not expose this appliance to rain and moisture. The apparatus shall not be exposed to dripping or splashing and no objects filled with liquids, such as vases, shall be placed on the apparatus.



This symbol, wherever it appears, alerts you to important operating and maintenance instructions in the accompanying literature. Please read the manual.

en

WARNING

THIS EQUIPMENT IS CAPABLE OF DELIVERING SOUND PRESSURE LEVELS IN EXCESS OF 90 dB, WHICH MAY CAUSE PERMANENT HEARING DAMAGE.



- 1) Read these instructions.
- 2) Keep these instructions.
- 3) Heed all warnings.
- 4) Follow all instructions.
- 5) Do not use this apparatus near water.
- 6) Clean only with dry cloth.
- 7) Do not block any ventilation openings. Install in accordance with the manufacturer's instructions.
- 8) Do not install near any heat sources such as radiators, heat registers, stoves, or other apparatus (including amplifiers) that produce heat.
- 9) Do not defeat the safety purpose of the polarized or grounding-type plug. A polarized plug has two blades with one wider than the other. A grounding type plug has two blades and a third grounding prong. The wide blade or the third prong are provided for your safety. If the provided plug does not fit into your outlet, consult an electrician for replacement of the obsolete outlet.
- 10) Protect the power cord from being walked on or pinched particularly at plugs, convenience receptacles, and the point where they exit from the apparatus.
- 11) The apparatus shall be connected to a MAINS socket outlet with a protective earthing connection.
- 12) Where the MAINS plug or an appliance coupler is used as the disconnect device, the disconnect device shall remain readily operable.
- 13) Only use attachments/accessories specified by the manufacturer.
- 14) Use only with the cart, stand, tripod, bracket, or table specified by the manufacturer, or sold with the apparatus. When a cart is used, use caution when moving the cart/apparatus combination to avoid injury from tip-over.
- 15) Unplug this apparatus during lightning storms or when unused for long periods of time.
- 16) Refer all servicing to qualified service personnel. Servicing is required when the apparatus has been damaged in any way, such as power supply cord or plug is damaged, liquid has been spilled or objects have fallen into the apparatus, the apparatus has been exposed to rain or moisture, does not operate normally, or has been dropped.
- 17) CAUTION - These service instructions are for use by qualified service personnel only. To reduce the risk of electric shock do not perform any servicing other than that contained in the operation instructions unless you are qualified to do so.



Caution! The unit contains a rechargeable battery. Rechargeable batteries must not be exposed to fire - this poses a DANGER OF EXPLOSION. Incorrectly replacing the battery poses a DANGER OF EXPLOSION. Only use batteries of the same type.

TABLE OF CONTENTS

1. INTRODUCTION	3
1.1 Before you get started	3
1.1.1 Shipment	3
1.1.2 Initial operation	4
1.1.3 Online registration	4
2. CONTROL ELEMENTS AND CONNECTIONS	4
3. SPECIFICATIONS	6
4. WARRANTY	6

1. INTRODUCTION

Thank you for expressing your confidence in us by purchasing the EPA40. The EPA40 is a portable PA system for business meetings, guides, school activities and many other applications. With its 5" full-range loudspeaker, it delivers an extraordinary sound in an extremely light housing. Thanks to the rugged construction, the included ULTRAVOICE XM1800S microphone is easy to handle, even under the toughest live conditions.

 **The following user's manual is intended to familiarize you with the unit's control elements, so that you can master all the functions. After having thoroughly read the user's manual, store it in a safe place for future reference.**

1.1 Before you get started

1.1.1 Shipment

Your product was carefully packed at the factory to ensure safe transport. Nevertheless, if the box is damaged inspect the unit immediately for signs of damage.

 **If the unit is damaged, please do NOT return it to us; instead, notify your dealer and the shipping company immediately, otherwise claims for damage or replacement may not be granted.**

 **Please always use the original packaging to avoid damage due to storage or shipping.**

 **Never let unsupervised children play with the EPA40 or with its packaging.**

 **Please dispose of all packaging materials in an environmentally friendly fashion.**

 **Rechargeable batteries must not be disposed of with household waste. Please take rechargeable batteries which are defective or no longer needed to a municipal or retail collection point. Rechargeable batteries must be discharged before being disposed of at a municipal or retail collection point. Rechargeable batteries which are not completely discharged must be protected against short-circuiting. The poles or electrical contact surfaces can be insulated with adhesive tape.**

1.1.2 Initial operation

 **CAUTION!** Before using the apparatus, you must charge the rechargeable battery for at least four hours. To charge, connect the apparatus to the provided power supply. The **CHARGE LED** indicates the battery's status. The battery is fully charged when the LED stops flashing.

Make sure you provide adequate ventilation. Do not place the device on top of a power amplifier or near a radiator to avoid overheating.

To power the EPA40, use only the power supply unit that is delivered with your equipment.

The battery must not be exposed to extreme heat (sun, open fire and similar risks)! The capacity of the battery may diminish at low temperatures.

en

 **Important notes concerning installation:** The sound quality may diminish within the range of powerful broadcasting stations and high-frequency sources. Increase the distance between the transmitter and the device and use shielded cables for all connections.

 **CAUTION!** The device is capable of producing extreme volume levels. Please keep in mind that high sound pressure levels not only impair the hearing, but can also cause permanent damage. Keep the volume at an appropriate level at all times.

1.1.3 Online registration

Please remember to register your new BEHRINGER equipment right after your purchase by visiting www.behringer.com (alternatively www.behringer.de) and read the terms and conditions of our warranty carefully.

Should your BEHRINGER product malfunction, our goal is to have it repaired as quickly as possible. To arrange for warranty service, please contact the retailer from whom the equipment was purchased. Should your BEHRINGER dealer not be located in your vicinity, contact directly one of our subsidiaries. Corresponding contact information is included in the original equipment packaging (Global Contact Information/European Contact Information). Should your country not be listed, please contact the distributor nearest you. A list of distributors can be found in the support area of our website (www.behringer.com).

Registering your purchase and equipment with us helps us process your repair claims quicker and more efficiently.

Thank you for your cooperation!

2. CONTROL ELEMENTS AND CONNECTIONS

1 LOUDSPEAKER.

2 CARRY HANDLE.

3 HOLES FOR SHOULDER STRAP.

4 The rotary *MIC LEVEL* control allows you to adjust the volume level.

5 The *POWER* switch turns the device on and off. When turned on, the LED of the *POWER* switch lights up.

 **Please note:** The *POWER* switch does not fully disconnect the unit from the mains. To disconnect the unit from the mains, pull out the main cord plug or appliance coupler. When installing the product, make sure the plug or appliance coupler is readily operable. Unplug the power cord when the unit is not used for prolonged periods of time.

6 The *CHARGE* LED flashes yellow as long as the rechargeable battery is charging. It goes out when the battery is fully charged.

7 The *LOW BAT* LED indicates that the rechargeable battery needs to be charged.

8 Connect the supplied BEHRINGER XM1800S microphone to the *MIC IN* input.

 **Never hold the microphone directly in front of the loudspeaker. Feedback hazard! When operating the device, keep the microphone behind the loudspeaker to avoid feedback.**

9 You can connect an external sound source (CD player, MP3 player, etc.) to the *LINE IN* input.

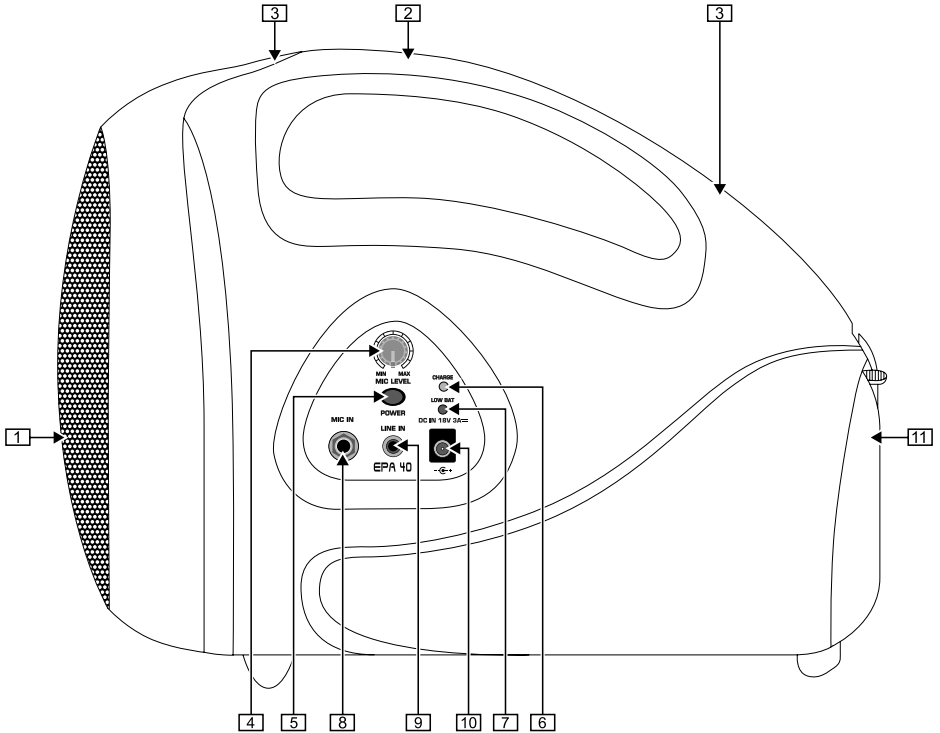

Fig. 2.1: Side view of the EPA40

10 Connect to the power supply via the polarized *DC IN* connector. A fitting power adapter is supplied. Use the device only with the included power supply.

11 **COMPARTMENT FOR BATTERY AND SHOULDER STRAP.** To insert the battery, open the compartment's cover. The bottom half of the compartment is used for the battery. Open the latch to access the battery compartment.

Insert the battery as follows: The terminals must face the device with the positive terminal (red) on the side of the EPA control panel (to the left, as seen from the rear panel). Insert the battery and close the latch. Close the battery compartment.

 **Insert the rechargeable battery with the terminals connected to the correct polarity.**

The device's *SERIAL NUMBER* is found on the bottom side of the unit.

3. SPECIFICATIONS

INPUTS

MIC IN	1/4" jack, unbalanced
LINE IN	1/8" jack, unbalanced

OUTPUT

Output power	40 W
Loudspeaker	5" full-range speaker

MICROPHONE

Type	BEHRINGER XM1800S, dynamic
Pickup pattern	Hyper-cardioid
Cable length	3' spiral cable

SYSTEM DATA

Power supply	with supplied rechargeable battery
Rechargeable battery type	12 V DC / 2600 mAh
Charging time	approx. 4 h
Battery operating time	up to 8 h
External recharger type	18 V DC / 3 A
Mains voltage	100 - 240 V~, 50/60 Hz (Switching mode adaptor)
Mains connector	Standard IEC receptacle

PHYSICAL/WEIGHT

Dimensions (H x W x D)	approx. 217 mm x 180 mm x 284 mm
Weight (without power supply)	approx. 2.6 kg

4. WARRANTY

§ 1 OTHER WARRANTY RIGHTS AND NATIONAL LAW

1. This warranty does not exclude or limit the buyer's statutory rights provided by national law, in particular, any such rights against the seller that arise from a legally effective purchase contract.
2. The warranty regulations mentioned herein are applicable unless they constitute an infringement of national warranty law.

§ 2 ONLINE REGISTRATION

Please do remember to register your new BEHRINGER equipment right after your purchase by visiting <http://www.behringer.com> and kindly read the terms and conditions of our warranty carefully. Registering your purchase and equipment with us helps us process your repair claims quicker and more efficiently. Thank you for your cooperation!

§ 3 WARRANTY

1. BEHRINGER (BEHRINGER International GmbH including all BEHRINGER subsidiaries, except BEHRINGER Japan) warrants the mechanical and electronic components of this product to be free of defects in material and workmanship for a period of one (1) year* from the original date of purchase, in accordance with the warranty regulations described below. BEHRINGER warrants the mechanical and electronic components of this product to be free of defects in material and workmanship for a period of one (1) year* from the original date of purchase, in accordance with the warranty regulations described below. If the product shows any defects within the specified warranty period that are not excluded from this warranty as described under § 5, BEHRINGER shall, at its discretion, either replace the product by providing a new or reconditioned product or repair the product using suitable new or reconditioned parts. In the case that other parts are used which constitute an improvement, BEHRINGER may, at its discretion, charge the customer for the additional cost of these parts.

In case BEHRINGER decides to replace the product, this warranty shall apply to the replacement product for the remaining initial warranty period, i.e. one year* from the date of purchase of the initial product.

2. If the warranty claim proves to be justified, the product will be returned to the user freight prepaid.
3. Warranty claims other than those indicated above are expressly excluded.

§ 4 RETURN AUTHORIZATION NUMBER

1. To obtain warranty service, the buyer (or his authorized dealer) must call BEHRINGER during normal business hours BEFORE returning the product. To obtain warranty service, the buyer (or his authorized dealer) must call BEHRINGER as exclusive distributor of BEHRINGER products (see enclosed list) during normal business hours

BEFORE returning the product. All inquiries must be accompanied by a description of the problem. The buyer or his authorized dealer will receive a return authorization number.

2. Subsequently, the product must be returned in its original shipping carton, together with the return authorization number. The return shipment address will be indicated by BEHRINGER.
3. Shipments without freight prepaid will not be accepted.

§ 5 WARRANTY REGULATIONS

1. Warranty services will be furnished only if the product is accompanied by a copy of the original retail dealer's invoice. Any product deemed eligible for repair or replacement under the terms of this warranty will be repaired or replaced.
2. If the product needs to be modified or adapted in order to comply with applicable technical or safety standards on a national or local level, in any country which is not the country for which the product was originally developed and manufactured, this modification/adaptation shall not be considered a defect in materials or workmanship. The warranty does not cover any such modification/adaptation, irrespective of whether it was carried out properly or not. Under the terms of this warranty, BEHRINGER shall not be held responsible for any cost resulting from such a modification/adaptation.
3. Free inspections and maintenance/repair work are expressly excluded from this warranty, in particular, if caused by improper handling of the product by the user. This also applies to defects caused by normal wear and tear, in particular, of faders, crossfaders, potentiometers, keys/buttons, tubes, guitar strings, illuminants and similar parts.
4. Damage/defects caused by the following conditions are not covered by this warranty:
 - ▲ improper handling, neglect or failure to operate the unit in compliance with the instructions given in BEHRINGER user or service manuals.
 - ▲ connection or operation of the unit in any way that does not comply with the technical or safety regulations applicable in the country where the product is used.
 - ▲ damage/defects caused by force majeure or any other condition that is beyond the control of BEHRINGER.
5. Any repair or opening of the unit carried out by unauthorized personnel (user included) will void the warranty.
6. If an inspection of the product by BEHRINGER shows that the defect in question is not covered by the warranty, the inspection costs are payable by the customer.
7. Products which do not meet the terms of this warranty will be repaired exclusively at the buyer's expense. BEHRINGER will inform the buyer of any such circumstance. If the buyer fails to submit a written repair order within 6 weeks after notification, BEHRINGER will return the unit. Costs for freight and packing will be invoiced separately C.O.D. When the buyer has sent in a written repair order such costs will also be invoiced separately.

§ 6 WARRANTY TRANSFERABILITY

This warranty is extended exclusively to the original buyer (customer of retail dealer) and is not transferable to anyone who may subsequently purchase this product. No other person (retail dealer, etc.) shall be entitled to give any warranty promise on behalf of BEHRINGER. No other person (retail dealer, etc.) shall be entitled to give any warranty promise on behalf of either BEHRINGER or BEHRINGER

§ 7 CLAIM FOR DAMAGES

Failure of BEHRINGER to provide proper warranty service shall not entitle the buyer to claim (consequential) damages. In no event shall the liability of BEHRINGER exceed the invoiced value of the product.

* Customers in the European Union please contact BEHRINGER Germany Support for further details.

BEHRINGER is constantly striving to maintain the highest professional standards. As a result of these efforts, modifications may be made from time to time to existing products without prior notice. Specifications and appearance may differ from those listed or illustrated.

Technical specifications and appearance are subject to change without notice. The information contained herein is correct at the time of printing. BEHRINGER accepts no liability for any loss which may be suffered by any person who relies either wholly or in part upon any description, photograph or statement contained herein. Colors and specifications may vary slightly from product. Products are sold through our authorized dealers only. Distributors and dealers are not agents of BEHRINGER and have absolutely no authority to bind BEHRINGER by any express or implied undertaking or representation. No part of this manual may be reproduced or transmitted in any form or by any means, electronic or mechanical, including photocopying and recording of any kind, for any purpose, without the express written permission of BEHRINGER International GmbH.

ALL RIGHTS RESERVED. (c) 2007 BEHRINGER International GmbH.

BEHRINGER International GmbH, Hanns-Martin-Schleyer-Str. 36-38,

47877 Willich-Muenchheide II, Germany. Tel. +49 2154 9206 0, Fax +49 2154 9206 4903

EUROPORT EPA40

FEDERAL COMMUNICATIONS COMMISSION COMPLIANCE INFORMATION



Responsible party name: **BEHRINGER USA, Inc.**
Address: **18912 North Creek Parkway, Suite 200
Bothell, WA 98011, USA**
Phone/Fax No.: **Phone: +1 425 672 0816,
Fax: +1 425 673 7647**

hereby declares that the product

EUROPORT EPA40

complies with the FCC rules as mentioned in the following paragraph:

This equipment has been tested and found to comply with the limits for a Class B digital device, pursuant to part 15 of the FCC Rules. These limits are designed to provide reasonable protection against harmful interference in a residential installation. This equipment generates, uses and can radiate radio frequency energy and, if not installed and used in accordance with the instructions, may cause harmful interference to radio communications. However, there is no guarantee that interference will not occur in a particular installation. If this equipment does cause harmful interference to radio or television reception, which can be determined by turning the equipment off and on, the user is encouraged to try to correct the interference by one or more of the following measures:

- ▲ Reorient or relocate the receiving antenna.
- ▲ Increase the separation between the equipment and receiver.
- ▲ Connect the equipment into an outlet on a circuit different from that to which the receiver is connected.
- ▲ Consult the dealer or an experienced radio/TV technician for help.

This device complies with Part 15 of the FCC rules. Operation is subject to the following two conditions: (1) this device may not cause harmful interference, and (2) this device must accept any interference received, including interference that may cause undesired operation.

Important information:

Changes or modifications to the equipment not expressly approved by BEHRINGER USA can void the user's authority to use the equipment.

www.behringer.com

